



ALLIED POS
Always Bringing More...



Central Billing Supplier - Point Of Sale Catalogue



On Shelf Merchandising & POS

Solutions For Retail

September 2023

**For More Choice,
Please Visit Our Websites**

www.hl-display.com

www.alliedpointofsale.ie

Or

**Visit Our Showroom.
Just 5 mins off the N7.**

Food for thought...

Shelf automation frees up staff from repetitive tasks

Up to 45% of staff hours are related to shelf management such as replenishment or price adjustments - Up to 50% of in-store tasks could potentially be automated

Sources: Oliver Wyman research and benchmarking 2018. McKinsey Perspectives on retail and consumer goods,



Next™

-24% time required for shelf merchandising

Nielsen test stores Sweden



Facer™

-36% time required for shelf merchandising

Nielsen test stores Sweden



Multivo™

-80% time required for installation & planogram changes

Comparison test with other system HL



Multivo™ Max

-35% time required for shelf merchandising

Nielsen test stores Sweden

Contact our office for advice & further details

They are back. *Sustainable*
Poly Display Crates To use on side stacks or on shelf as part of a display. Page 23



Fold Away While Not In Use



What's New
Banana Tree Floor Stand
page 33



Contact : Phone 01 4587470 E Mail: salesireland@hl-display.com



Contents

Page 2-3	Multivo™ Max Shelf Management for Chilled Pre-Pack & Larger Products
Page 4-5	Facer™ Shelf Management for Off-Licence & Glass Jars
Page 6-7	Multivo™ Shelf Management for Ambient Grocery
Page 8-9	Next™ Shelf Management for Upright Freezers & Confectionary
Page 10-12	Simple Click™ Cool System – Designed For Chilled Presentation
Page 13	RollerTrack™ - Healthy Drinks Chilled, Dairy, Juices & Food Academy
Page 14-15	Optimal™ Shelf Management – Chilled Produce & Ambient
Page 16-17	Sigma™ Shelf Management for Ambient Grocery
Page 18-19	Freshcase™ Shelf Management for Off-Licence & Glass Jars or Bottles
Page 20	Vintage Look - Feature Display – Carts
Page 21	Artisan Look – Floor Standing Poly Wicker Display & Accessories
Page 22-23	Artisan Display Props & Poly Crates
Page 24-25	New Format Shelf Talkers - Bakery Treat & Standard Shelf Talkers
Page 26-27	Shelf Fronts – Data Strips - Risers & Biscuit Stops
Page 28-31	Imitation Food Props – Cheese, F&V, Continental Meats, Garlands & Fish Counter
Page 32	Feature Display – Tables
Page 33	Banana Tree & The Adaptable Floor Stand - Using Poly Crates, Poly Wicker or Latted Crates.
Page 34-35	Tiered Counter Stands – Poly Wicker Baskets & Accessories - Artisan Display
Page 36	Artisan Display- Risers & Props
Page 37-38	Presentational Food Display Platters – Melamine & Wood Effect Melamine
Page 39	Condiment Holders & Food Tasting Units
Page 40	Mesh Menu Holders, Chalk Effect Tickets & Chalk Pen Accessories
Page 41	Stainless Steel Deli Ticketing & Hot Counter Ticket Solutions
Page 42-43	Serve Over Pricing Solutions –s, Ticket Stands & Clips
Page 44-45	Vintage Look Wine Display – Crates, Barrels, Props & POS
Page 46-47	Coloured Wood Crates – Shelved Crates – Crate Bundles
Page 48-49	Chalk Board Menu Holders - & Chalk Board Signage
Page 50-51	Chalk Board – Table Top & Silhouette Shaped
Page 52	Something Different - Signage & Display Signage
Page 53-54	Wood Clip Board & Menu Block Solutions
Page 55	Merchandising Hooks, Crossbars & Accessories
Page 56	HACCP Station - Pump Toppers - Menu Holders – Acrylic & Acrylic with Plywood Base
Page 57	Poster & Signage Holders
Page 58	Frames & Accessories – Sets
Page 59	Branded Special Offer Display Bins & Frames & Accessories – Parts
Page 60	Shelf Edge Merchandising Strips
Page 61	Brochure Stands & Counter Top/Wall Mounted Brochure Holders
Page 62	Elevating Key Categories Lift & Drop™ Signage Holders & Category Banner Solutions
Page 63	Pavement Signage & Snap Frames
Page 64-65	Shopping Baskets, Kick Stools, Bag Holders Pricing Guns & Miscellaneous Items
Page 66-67	Queue System with Merchandising Options – Accessories & Parts
Page 68	Fresh Off The Press – New Magazine Racks - Newspaper Floor Stands
Page 69	Queue Barriers & Ceiling Signage Accessories



Multivo™ Max The low maintenance pusher system when extra strength is needed

Multivo™ Max ensures well-merchandised shelves and efficient space usage while saving time on daily shelf maintenance.

Key benefits

- Automated front-facing for more efficient shelf management
- Suitable for a variety of packaging formats & sizes
- Easy to install and maintain



Flexible merchandising for various packaging formats & easily installed

Given the large number of SKUs in many categories such as chilled foods, ensuring product visibility even through busy trading hours is key.

Creating more product visibility & shop-ability, while providing operational benefits, as less time will be needed to maintain shelf or display integrity.

Recommended Categories

- Pre Pack Bagged Salad & Bagged Veg
- Pre Pack Red Meats & Cooked Meats
- Breakfast Meats
- Pre Pack Cheese
- Pre Pack Ready Meals
- Pre Pack Fish



Prepack Produce Average Facings Per 1250mm Shelf	Parts Needed For Average 1250mm Shelf within a Full Bay – Depth of shelf to be measured & shared when ordering.	Assembly Code
Cooked Meats Pre Pack Av 7 Facings	Magnetic Front x 1 – Two sided divider Pusher x 1 – One sided divider Pusher x 6 (2x12N spring)	MM SHELF PPMeat
Red Meats Pre Pack Av 6 Facings	Magnetic Front x 1 – Two sided divider Pusher x 1 – One sided divider Pusher x 5 (2x12N spring)	MM SHELF PPRAW MEATS
Cheese Pre Pack Av 6 Facings	Magnetic Front x 1 – Two sided divider Pusher x 1 – One sided divider Pusher x 5 (2x12N spring)	MM SHELF PPCheese
Breakfast Meats Av 6 Facings	Magnetic Front x 1 – Two sided divider Pusher x 1 – One sided divider Pusher x 5 (2x12N spring)	MM SHELF Breakfast
Ready Meals Pre Pack Av 6 Facings	Magnetic Front x 1 – Two sided divider Pusher x 1 – One sided divider Pusher x 5 (2x12N spring)	MM SHELF PPRReadyMeals
Fish Pre Pack Average 7 Facings	Magnetic Front x 1 – Two sided divider Pusher x 1 – One sided divider Pusher x 6 (2x12N spring)	MM SHELF PPFish
Pre Pack Salad/Veg Average Facings Per 1250mm Shelf	Parts Needed For Average 1250mm Shelf within a Full Bay – Depth of shelf to be measured & shared when ordering.	Assembly Code
Bagged Salads Av 6 Facings	Magnetic Front x 1 – Two sided divider Pusher x 1 – One sided divider Pusher x 5 (1x12N spring)	MM SHELF Prepack SALAD
Prepacked Veg Av 6 Facings	Magnetic Front x 1 – Two sided divider Pusher x 1 – One sided divider Pusher x 5 (2x12N spring)	MM SHELF Prepack VEG

Please provide your shelf measurements when ordering. If unsure of product categories, just snap and send your query to salesireland@hl-display.com

Multivo™ Max Piece Parts



Multivo Max™ with two metal dividers

A straight, upright pusher to be used at the end of each shelf. One double divider pusher per shelf. Adjustable in width from 110-250mm. Contact our office for further details or advice from our sales team.

Multivo Max™ with one metal divider

A straight, upright pusher to be used at the end of each facing. Adjustable in width from 110-250mm. Contact our office for further details or advice from our sales team.



Multivo Max™ with 2 wire dividers

A straight, upright pusher to be used at the end of each shelf. One double divider pusher per shelf. Adjustable in width from 210-355mm. Contact our office for further details or advice from our sales team.

Multivo Max™ with 1 wire dividers

A straight, upright pusher to be used for each facing.. Adjustable in width from 210-355mm. Contact our office for further details or advice from our sales team.



Multivo™ Magnetic Front Rail

Used to mount Multivo™ on metal shelves. Comes with a strong magnetic base for positioning on shelf.



Facer™ Front-faced in one pull

Facer™ is a width-adjustable steel frame, placed on shelf hidden behind a front riser - simply lift the frame, pull forward, put the frame back into place.

Key benefits

- Simplified refilling and front-facing, save 38% on shelf merchandising
- Lowers risk of overstocking and broken bottles
- Keeps products aligned



Implement Shelf Discipline & Stop Product Fanning at the rear of Shelf

Facer™ frames reduce the risk of overfilling and damaging bottles while ensuring well-merchandised products and can be used in almost any category. Each lane of bottles or cans are maintained in a width-adjustable steel frame hidden behind the front riser, which stops facings increasing or product fanning, towards the back of the shelf.

The frames are placed directly on the shelf and work whichever way they are installed. To front-face, lift the frame up from behind the riser, pull the frame forward, dragging the products to the front of the shelf and slide the frame back into place behind the front riser.

Recommended Categories

- Chilled or Ambient Wines
- Craft Beers
- Spirits
- Olive Oils
- Glass Jars/Bottles
- 1.5L Soft Drinks
- Ambient Groceries



Off-licence Average Facings Per 1 Meter Shelf	Parts Needed For Average 1M Shelf within a Full Bay – Depth of shelf to be measured & shared when ordering.	Assembly Code
Bottled Wines Average 12 facings per 1M	Facer Front x 1 – Facer 68-110 x 12	Facer 1M x12
Bottled Craft Beer Average 14 facings per 1M	Facer Front x 1 – Facer 68-110 x 14	Facer 1M x14
Canned Beer Average 15 facings per 1M	Facer Front x 1 – Facer 47-70 x 15	Facer 1M x15
Ambient 1M shelves Facings	Parts Needed For Average 1M Shelf within a Full Bay. Depth of shelf to be measured & shared when ordering.	Assembly Code
Ambient with 12 facings	Facer Front x 1 – Facer 68-110 x 12	Facer 1M x12
Ambient with 13 facings	Facer Front x 1 – Facer 68-110 x 13	Facer 1M x13
Ambient with 14 facings	Facer Front x 1 – Facer 68-110 x 14	Facer 1M x14
Ambient with 15 facings	Facer Front x 1 – Facer 47-70 x 15	Facer 1M x15

Please provide your shelf measurements, both Depth & Width & Number of facings when ordering. If unsure of product categories, just snap and send your query to salesireland@hl-display.com

Facer™ Piece Parts



Facer™ Pull Frame. Frames in adjustable width and available in different lengths to suit shelf depths. Standard Colour Grey RAL 9006

Width 68mm to 110mm depth 445mm Code: 899981

Width 68mm to 110mm depth 555mm Code: 741971

Width 47mm to 70mm depth 455mm Code: 749569

Width 47mm to 70mm depth 555mm Code: 749570

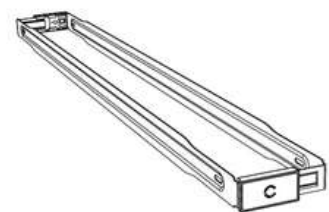

For Larger Pack Sizes - Facer™ Pull Frame XL

Width 100mm to 200mm Depth 455mm Code: 528554

Width 100mm to 200mm Depth 485mm Code: 528547



Facer™ Rear Clip Support. The Rear Support clips onto the back of the Facer Pull Track, providing support and stability for taller bottles and products. Standard Colour Grey. Width 63mm to 101mm depth 12mm Code: 459208



Facer™ Front Riser. Front Profile for Facer™ frames, with integrated front riser & label pocket. High Gloss finish. Standard Colour Grey coS24

Width 1000mm Depth 21mm Label Height 26mm Code: 459099

Width 1245mm Depth 21mm Label Height 26mm Code: 459100



Multivo™ Simplify daily maintenance and planogram changes



Multivo™ is a shelf merchandising system that makes the daily work of refills, front-facing and planogram changes easier and faster than ever.

Key benefits

- Save time on shelf maintenance due to automated front-facing and faster refilling
- Always attractive shelves
- Easier and faster fixture changes – save up to 80% vs other systems

Improve Product Visibility

- Always front facing, your on shelf product is at maximum visibility, all the time, automatically.
- Visibility is Shop-ability, front facing improves access to harder to reach areas, such as top and bottom shelves.
- Adjustability to suit a number of packaging types & sizes.



Recommended Categories

- Personal Care
- Well Being – Supplements
- Medicinal & Vitamins
- Deodorants
- Hair Care
- Baby Needs & Baby Food
- Ambient Grocery



Category – Average Facings Per 1M Shelf	Parts Needed For Average 1M Shelf within a Full Bay. Depth of shelf to be measured & shared when ordering.	Assembly Code
Hair Care – Average 13 Facings Per 1000mm shelf	1 x Multivo Front Rail – 12 x Multivo T dividers 50P(All 9N pushers) – 1 x Left End – 1 x Right End	MUL HAIRCOL Shelf 1M
Deodorants – Average 17 Facings Per 1000mm shelf	1 x Multivo Front Rail – 17 x Multivo L dividers Left End 25P(6N pushers) – 1 x Right End	MUL DEO Shelf 1M
Medicinal– Push Feed. Average 13 Facings per 1000mm shelf	1 x Multivo Front Rail – 11 x Multivo T dividers 50P(2x9N & rest 6N pushers) – 2 x Left End with 25P(6N pushers) – 1 x Right End	MUL MEDICINAL Shelf 1M
Vitamin – Push Feed. Average 14 Facings per 1000mm shelf	1 x Multivo Front Rail – 10 x Multivo T dividers 50P (1x9N & rest 6N pushers) – 4 x Left End with 25P(6N pushers) – 1 x Right End	MUL VITAMIN Shelf 1M
Average Shelf Push Feed Personal Care 16 facings per shelf 1000mm	1 x Multivo Front Rail – 6 x Multivo T dividers 50P with 9N spring & 6 x Multivo T dividers 50P with 6N spring - 4 x Left End with 25P with 6N spring – 1 x Mid Track Pusher with 9N spring - 1 x Right End	MUL PCARE AV Shelf 1M

Please provide your shelf measurements, both Depth & Width & Number of facings when ordering. If unsure of product categories, just snap and send your query to salesireland@hl-display.com

Multivo™ Piece Parts



Multivo™ L divider, for left hand side of the shelf, combined with 50mm wide by 65mm high pusher on the right side. The pusher has a plate that extends to the right or fully up to facilitate pushing larger products. One required for each shelf. Available with a medium strength 6 Newton Spring pusher or for more strength 9N Spring may be required for heavier products.



Multivo™ T dividers, combined with 50mm wide by 65mm high pusher on the right side. The pusher has a plate that extends to the right or fully up to facilitate pushing larger products. Being a mid shelf pusher there is one pusher less than the number of facing required per shelf. Available with a medium strength 6 Newton Spring pusher or for more strength 9N Spring may be required for heavier products



Multivo™ L divider, for left hand side of the shelf, combined with 25mm wide by 65mm high pusher on the right side. The smaller size pusher plate facilitates pushing products of 25mm to 49mm in diameter. This pusher can be used multiple times on a shelf if required.



Multivo™ right hand end divider with no pusher. One required for each shelf.



Used to mount Multivo™ and Multivo™ Max on metal shelves. Comes with a strong magnetic base for positioning on shelf.



Next™ Maximise merchandising space and product visibility



Next™ is a shelf-less pusher tray system sitting on crossbars which allows more products to be displayed and is suitable for sub-zero temperatures.

Key benefits

- Automated front-facing ensures less time required to manage the fixture - save 24% on shelf merchandising.
- Efficient space usage
- Improved product and price visibility



Create a wall of products and enhance the category

Trend towards vertical freezers increases need for front-facing solutions for efficient merchandising and improved shopping experience.

With Next™, different packaging and product sizes can be presented next to each other, even the most difficult!

Recommended Categories

- Bagged Sweets
- Confectionary
- Block Chocolate
- Frozen Food
- Fruit & Veg
- Ambient Prepack



Ambient Category Average Facings Per bay	Parts Needed For Average Shelf within a Full Bay. Depth of shelf to be measured & shared when ordering.	Assembly Code
Bagged Sweets Average 6 facings per 1M	Crossbar 1M x 1 – Next Trays x 6	Next Sweets 1M CBar
Block Chocolate Average 10 facings per 1M	Crossbar 1M x 1 – Next Trays x 10	Next Block Choc 1M CBar
Ambient Prepack Fruit & Veg Average 6 facings per 1.25M	Crossbar 1.25M x 1 – Next Trays x 6	Next AMB F&V 1.25M CBar
Frozen Average bay Facings	Parts Needed For Average Shelf within a Full Bay. Depth of shelf to be measured & shared when ordering.	Assembly Code
Pizza 12" Average 4 facings per 1.25M	Crossbar 1.25M x 1 – Next Pizza Tray x 4	Next Pizza 1.25M CBar
Average facings per door on average frozen, 630mm width door.	Crossbar 630mm x 1 – Next Tray x 4	Next Frozen Door AV 630mm

Please provide your shelf measurements when ordering. If unsure of product categories, just snap and send your query to salesireland@hl-display.com

Next™ Piece Parts

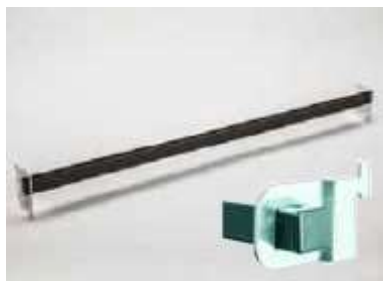

Next™ Crossbar with euro brackets

With Euro brackets and plastic end plugs. One bar style fits all uprights, widths include 1000mm and 1250mm version..

Width 1000mm Code: 887645

Width 1250mm Code: 887646

Other Crossbar sizes can be available, please contact our sales team for more information or availability.



Next™ Pusher Tray

3" Tray Extendable width from 84 - 165mm. Two dividers per tray. Comes with SEL holder. Depth of tray 483mm to suit 500 to 570mm base shelf.

Code: 890779



5" Tray Extendable width from 135 - 305mm. Two dividers per tray. Comes with SEL holder. Depth of tray 483mm to suit 500 to 570mm base shelf.

Code: 890756

3" Tray Extendable width from 84 - 165mm. Two dividers per tray. Comes with SEL holder. Depth of tray 381mm to suit 400 to 470mm base shelf.

Code: 890747



Next™ Pizza Tray for crossbars. Extendable from 190 - 410mm with two low wire dividers for round pizzas.

Depth of tray 381mm, suitable for 400 base shelf.

Code: 525811



Key benefits

- Always Front Facing Push Feed.
- Better Presentation Promotes Impulse Sales.
- Suitable for a variety of packaging formats
- Improve Stock Rotation & Reduce Waste
- Reduce Costs, Less Labour Intensive.
- Better Visibility of Range, allows customers to find product easily.
- Instant identification of off sales.
- Improves Category & Store Image.



Recommended Categories

- Pre Pack Bagged Salad & Bagged Veg
- Pre Pack Cooked Meats & Red Meats
- Breakfast Meats
- Pre Pack Cheese
- Pre Pack Ready Meals
- Pre Pack Fish
- Front Of Store Fridge
- Yogurts & Desserts
- Fruit & Veg
- Health & Wellness Fruits, Seeds & Nuts Bay.

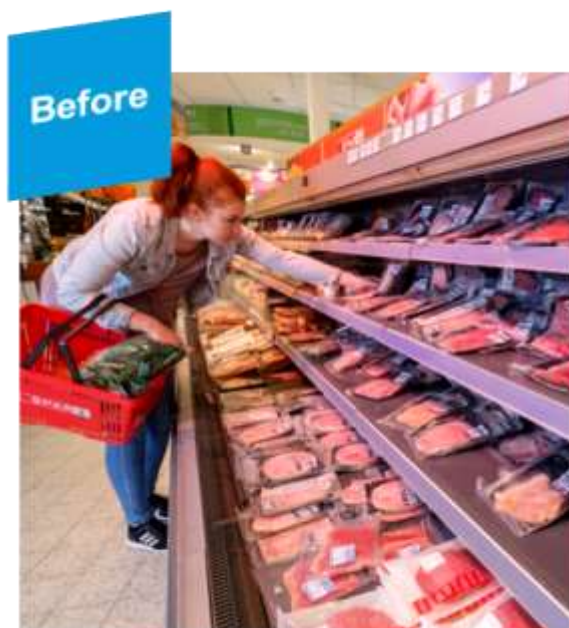

Prepack Produce Average Facings Per Shelf	Parts Needed For Average Shelf within a Full Bay	Assembly Code
Cooked Meats Pre Pack Av 7 Facings	Magnetic Front x 1 – Divider x 8 – Pusher x 6	CPMeat PP
Cheese Pre Pack Av 8 Facings	Magnetic Front x 1 – Divider x 9 – Pusher x 6	CPCheese PP
Breakfast Meats Av 6 Facings	Magnetic Front x 1 – Divider x 7 – Pusher x 4 – Ladder & Support x 2	CPBreakfastPP
Ready Meals Av 6 Facings	Magnetic Front x 1 – Divider x 7 – Pusher x 3 – Ladder & Support x 2	CPRMealsPP
Pre Packed Fish Average 7 Facings	Magnetic Front x 1 – Divider x 8 – Pusher x 5	CPFishPP
Prepack Salad/Veg Average Facings Per Shelf	Parts Needed For Average Shelf within a Full Bay	Assembly Code
Bagged Salads Av 5 Facings	Magnetic Front x 1 – Divider x 6 – Large Magnetic Support x 5	CP PPSALAD
Prepacked Veg Av 6 Facings	Magnetic Front x 1 – Divider x 7 – Large Magnetic Support x 6	CP PPVEG



Category – Fruit, Seeds & Nuts 1M Bay Average Facings	Parts Needed For Average Shelf within a Full Bay Per 1M Shelf x 470mm shelf	Assembly Code
Fruit, Seeds & Nuts – Push Feed Average 9 Facings	Magnetic Front CP x 1 – CP Divider x 10 – 14N CP Pusher x 9	FRUIT SEED & NUTS Push
Fruit, Seeds & Nuts – Divide Only. Average 9 Facings Per	Magnetic Front CP x 1 – CP Divider x 10	FRUIT SEEDS & NUTS Divide



Front Of Store Fridge - Average Facings Per Shelf	Parts Needed For Average Shelf within a Full Bay	Assembly Code
Front Of Store Fridge 1335mm width	Magnetic Front 667mm x 2 – Divider x 11	CP CT FOS Fridge
Front Of Store Fridge 1m width	Magnetic Front 985mm x 1 – Divider x 10	CP CT FOS Fridge 1M
Divide Only Chilled Average Facings Per Shelf	Parts Needed For Average Shelf within a Full Bay	Assembly Code
Sandwich / Wraps / Fruit Bowls	Magnetic Front x 1 – Divider x 6	CP SWFB
Yogurts Divide Only	Magnetic Front x 1 – Divider x 6	CP YOGURTS
Prepack Raw Meats While Divide Only	Magnetic Front x 1 – Divider x 4	CP RAW MEATS

SimpleClick™ Piece Parts

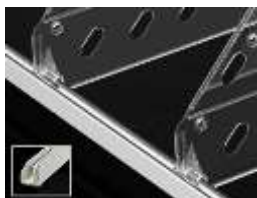

Fresh Front Rail Magnet, silver, length 1250mm. Use together with the Cool snap-off dividers, and /or Cool Product Pusher / Cool Ribbed Base and Standard Support or Large Support. Code: CP PA-1003

Fresh Breakable Divider 140mm high & breakable from 485 to 285 deep. Use together with the Cool Front Rail. Due to the specially developed nose of the Cool snap-off divider, rear attachment is not necessary. Code: CP PA-1008

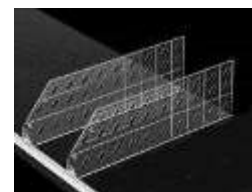

Fresh Product Pusher. The telescopic rail is adjustable and fits shelves from 330mm to 600mm. The pusher can be mounted both upright and at an angle for product display purposes. Suitable for Meat, Cheese, Ready Meals & Fish for product weights from 150gr to 250gr Code: CP ZLH 1401

Fresh Presentation Standard Ladder & back support For use when products are difficult to push, such as cling film type packs. A spring loaded pusher can still be used to provide support if wanted, but may not be as effective. Size 80mm W by 140mm H Code: CP PA-1009 + CP PA-1010

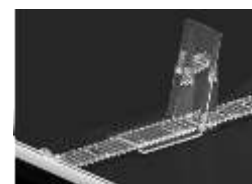

Fresh Large back support Magnetic For use when products are large, heavy or bagged, such as cellophane packs, such as Bagged Salad or Prepped Veg. Size 120mm W by 185mm H Code: CP PD 6014Magnetic

Roller Track™

The shelf-ready gravity feed system that ensures well-faced shelves and a higher level of product visibility.



Key benefits

- Avoid perceived out of stock with automated front-facing
- Suitable for variety of packaging formats and sizes
- Easy to install, use and maintain

Roller Track™ can be installed directly onto your current shelf, on angled shelves or used with angle provider for flat shelves. It will help maintain good stock rotation and detect empty facings instantly. Sheets come in different widths, depths & a variety of Front Risers. Dividers would be recommended to keep the integrity of the shelf plan to ensure easy refilling, facilitate stock rotation & easily highlight off sales.



Recommended Categories

- Desserts or Fresh Cakes
- Healthy Drink Chilled
- Dairy
- Food Academy
- Soft Drinks
- Juices



Please provide your shelf measurements, both depth & width, along with number of facings per shelf, when ordering or making your enquiry. If unsure of product categories, just snap and send your query to salesireland@hl-display.com

For enquiries please call our sales team on 01 -4587470 or email us at salesireland@hl-display.com



Clear Shelf Segmentation For Chilled Produce



Breakable T Divider 120 mm high with "T" Front Size: available to suit shelf depths 300 up to 500
Code:860028

Magnetic "T" Rail for use when fixing shelf management in place. Size : 1245 mm
Code: 301197



Ladder for Support
Code: 303295
Size: Adjustable from 285mm To 485mm

Support for Ladder
Code: 387119
Size:60mm x 120mm



Freestanding back support, used to keep irregularly shaped packaging (such as pre-packed or vacuum-packed products) standing straight. No rail needed as the base is magnetic. Size is 90mm High x 135mm wide.
Code: 397995



Areas of use for full System

- Pre-packed Cooked Meats
- Pre-packed Breakfast
- Ready Meals
- Bagged Salad
- Pre-packed Cheese

Areas to use dividers only

- Yoghurts
- Fats or Spreads



HL Sustainable Choice

All Optimal™ dividers and pushers are made from **20% up to 100% recycled plastic.**

For more information on sustainable choice please call our sales team on 01 -4587470 or email us at

salesireland@hl-display.com



Optimal™ Clear Shelf Segmentation For Ambient Grocery while organizing shelf by variant.

Divider, breakable from 285-485, 60mm high. Mounted on T-rail at the front and the OBR+ rail at the back. When used with a pusher or on angled shelves, choose suitable front stop. Break points every 25 mm. Code: 866970



Divider, breakable from 285-485, 25mm high. Mounted on T-rail at the front and the OBR+ rail at the back. When used with a pusher or on angled shelves, choose suitable front stop. Break points every 25 mm. Code: 874907



T Front Divider, breakable from 285-485, 60mm high. Mounted on T-rail at the front and the OBR+ rail at the back. When used with a pusher or on angled shelves, choose suitable front stop. Break points every 25 mm. Code: 868401



Pushers recommended for use on lighter products, such as Vapes or Tobacco



OP50B+ Pusher 50mm Wide, breakable from 285-485, 50mm wide 9N Spring. Mounted on T-rail at the front and the OBR+ rail at the back. Break points every 25 mm. For end stop use OP50B STOP-MINI (Below product). Code: 154183

Front stop, 55mm high, straight, automatic flip down. Mounted on a OP50 track. Automatic flip down front makes product loading simpler and quicker especially for high products and tight shelves. Code: 164038



OP25B+ Pusher, breakable, 25mm wide 6N Spring. Mounted on T-rail at the front. Break points every 25 mm. Used together with front stop dividers or an front stop profile like OFRK. Code: 887157

Optimal™ Fixing Rails



Front Rail - U-channel profiles can be used for all shelves with a front "U" channel. For 1 Meter Shelves (eg. Tego) Code: OTEF (988mm317334)

U-channel profiles can be used for all shelves back of shelf "U" channel. For 1 Meter Shelves (eg. Tego) Code: OBRT+ (988mm 870614)

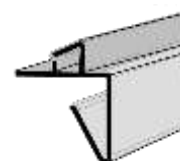

Adhesive Front profiles can be used for all shelves. Size 1245mm long with a 9mm tape for fixing in situ. Code: OPB (1245mm 305921)



Adhesive Back profiles can be used for all shelves. Size 1245mm long with a 19mm tape for fixing in situ. Code: OBR+ (1245mm 875273)



Sigma™ Create an inspiring visual shopping experience in Fruit & Vegetable Chilled



Sigma™ creates abundant-looking display without need for large inventory that can be lost to shrink.

Shelving and racking units made of anodized aluminium that will never rust, peel, chip or flake.

Key benefits

- Drives sales – up to 30% sales increase in test stores
- High durability, light and easy handling
- Create disruption within a signpost category

Improve both profitability and sustainability

Fresh produce is a destination category, signposting quality and driving traffic to store.

As concerns around food and packaging waste are increasing, the category offers an opportunity for retailers to showcase their commitment towards sustainability by merchandising fresh produce without packaging.

With the right merchandising systems such as Sigma™, retailers can create stunning display, reduce food waste, and increase sales and profitability.



Recommended Category

- Chilled Fruit & Vegetable



A food safe merchandising system for chillers

Effective cooler circulation with aluminium shelving. Aluminium is one of the best conductors of temperature, drawing out and dissipating heat quicker than steel, which ensures effective cooler circulation and maximises refrigeration air flow.

Sigma™

Products Flexibility & Combinations



Four High Block Merchandised POD - Curved design encourages impulse purchases with produce closer to the customer and provides a stunningly dramatic profile for full length wall cases. Fits chiller bay size: Width 1250mm.

Kit Contents as listed below:

- 4 x 1250mm mounting bars and brackets in pairs
- 2 x 350D semicircle pod rows with front riser (H row)
- 2 x 450D semicircle pod rows with front riser (H row)
- Pod row contains price label holders and baffle holders (to stop merchandise falling down the back of display, Risers & C channel for pricing).

Five High POD Disruptive merchandising - Curved design encourages impulse purchases with produce closer to the customer and provides a stunningly dramatic profile for full length wall cases. Fits chiller bay size: Width 1250mm.

Kit Contents as listed below:

- 4 x 1250mm mounting bars and brackets in pairs
- 1 x 350D semicircle pod rows with front risers (H row)
- 1 x 350D semicircle & quadrant shelf edge pod rows with front risers (HQ row)
- 2 x 450D semicircle pod rows with front riser (H row)
- 1 x 450D semicircle & quadrant shelf edge pod rows with front risers (HQ row)
- Pod row contains price label holders and baffle holders (to stop merchandise falling down the back of display, Risers & C channel for pricing).



Accessories - False bottom bin

Aluminum bin with removable clear front and angled false bottom to control amount of stock displayed, used at the base and two needed per bay.

Size W 610mm x D 559mm x H 254mm [Code: 173498](#)



The above are suggested setups to fit per one bay of 1250mm wide chiller units. For further options please contact our office for details or advice.



Freshcase™ Ambient Fruit & Vegetable



Freshcase™ is a modular display system for ambient shelves, tables and walls. Various sizes and shelf fronts allow for flexible merchandising to fitting most retailer needs..

Key benefits

- Possible to combine different size of FreshCase to maximize rotation and variety
- Complementary to Sigma™ to create holistic presentation
- Easy to install & clean

Recommended Category

- Ambient Fruit & Vegetable



Freshcase™ Ambient Fruit & Vegetable



Create a cascade of fresh produce

Merchandising for ambient tables and shelves

- Can be installed on cross bars or on shelves
- Part of our **Sustainable Choice** range and is 90% recycled, mainly from post-consumer sources
- The food contact surface is a food grade ABS material with anti-bacterial additives

Freshcase™ Piece Parts

Crossbar with euro brackets With Euro brackets and plastic end plugs. One bar style fits all uprights, widths include 1000mm and 1250mm version..
Width 1000mm Code: 887645
Width 1250mm Code: 887646



FreshCase® tray merchandising system for fresh produce, ideal for tables and shelf mounted displays. When mounting on the crossbar above, please note that the below support bracket will be needed.
Height 100mm, Depth 400mm.
Width 300mm Code: 159477
Width 400mm Code: 159473

FreshCase® crossbar bracket needed to support the Freshcase installation onto the 25mm crossbar.
Width 300mm Code: 162076
Width 400mm Code: 162077



FreshCase® divider 3mm clear “L” shaped divider for FreshCase with curved front. Works on all trays
Code: 585704

For suggested setups or advise to fit per 1000mm or 1250mm wide bays, please contact our office on 01 - 4587470 for further details.



The Vintage Look Tram – Cart & Accessories

Market cart made of high-quality natural mango wood

- Make a Statement
- Attract Attention
- Promote Impulse Sales
- Fully Assembled.
- Mobile, easy repositioning.
- Weather-resistant,
- High End Presentational Feature Display



Basic Model



The dimensions of the Basic Model are H 820mm W 1500mm D 800mm. The Chassis is black with solid black lacquered finish with solid rubber tyres. Material for cart top is mango wood colourless lacquer & metal edged corners. Code: TM BASIC

Classic 2 Wheel



The dimensions of the Classic 2 Wheel Model are H 780mm W 800mm D 800mm. The Chassis is black with solid black lacquered finish with solid rubber tyres. Material for cart top is mango wood colourless lacquer. Code: TM CLASSIC 2

The dimensions of the Classic 3 Wheel Model are H 770mm W 1250mm D 700mm. The Chassis is black with solid black lacquered finish with solid rubber tyres. Material for cart top is mango wood colourless lacquer & metal edged corners. Code: TM CLASSIC 3



Classic 3 Wheel



The dimensions of the Classic Model carts are H 820mm W 1700mm D 750mm. The shelf size is H 450mm W 1680mm D 450mm. The chassis is black with solid rubber tyres. The unit has a weight loading of maximum 100KG. Capacity of top 1.9 Square Meters. Code: TM CLASSIC

Classic Model

Still looking for More.....

Add extra dimension to your display with additional display crates & Display counter tops to tier crates as shown. As our sales team for more details.

Canopy Cover. Canopy Top comes in a choice of colours & materials, with flat or wave edging finish, for variation options, please contact our office. The dimensions of the above canopy structure is H 1230mm W 1750mm D 1040mm. When fitted the distance from the ground to the top of the canopy is 2050mm. Code: TM CO-COVER



Poly-Wicker Display

Ideal for Secondary Sighting Sales at Serve Over Counters or Make an Impactful Display in All Areas of Your Store...



Poly-wicker floor display baskets are food-safe, & washable. Ideal for creating impactful side displays and can be used in various areas around your store.. Colour options are Grey & Chestnut. The set is made up of 1 large, 1 medium & 1 small basket. The basket is woven around a steel frame for extra support.

Large Basket Size: 700mm H x 580 Diameter top & 440 at bottom with a basket insert 600mm diameter with a depth of 230mm.

Large Basket & Top

Chestnut Code: PWChestnut LG or Grey Code: PWGB LG .

Medium Basket Size: 500mm H x 450 Diameter top & 285 at bottom with a basket insert 600mm diameter with a depth of 230mm. MED Basket & Top

Chestnut Code: PWChestnut MED or Grey Code: PWGB MED

Small Basket Size: 400mm H x 450 Diameter top, with a basket insert 450mm diameter with a depth of 100mm. Small Basket & Top Chestnut Code: PWChestnut Small or Grey Code: PWGB Small



POS for Poly Baskets

Birch Ply A6 Portrait or Landscape Shelf Talker Holder (sealed for food safety). Open slot on short edge for inserting messages. Shown with Black clamp for fixing to Poly Baskets.

Portrait Code: WOD 20P + 9173217

Landscape Code: WOD 20L + 9173217

Poly Wicker Ticket Holder. PETG hook over clip for Poly Wicker Floor Displays. Ticket holder size is 115mm by 40mm high.

Code:PWICKER TICKET HOLDER



Your Five A Day Floor Stand

Black Metal Floor Stand, comes with 3 Poly-wicker wedge shape baskets with rounded front(Food Safe). Promote additional sales while adding perceived value to your offering. Stand Size: 520mm Diameter by 1060mm High.

Basket Size:500mm x 350mm x 100mm. Code:SP300+BT-1050

For signage solutions Clamp holder above or Clamp Holder on page 59 could be POS options for the 5 A Day Stand...



Display Props

Pre-Pack double Angled Display Steps



Two Tier Angled Step for displaying Pre Packed Cooked Meats. For use in Mid floor Spider Chilled units (Flat Bed or Shelved). The step is 280mm by 200mm in size and has routed slots on the base for airflow. The typical spider unit uses 15 to 18 Double steps per 1250W unit. The shelved Spider units will use 20 – 24 units depending on pack sizes. Material - PETG 3MM Code: PETG-2STEP



Pizza Display Steps



Angled Step for display of Fresh Pizza. For use in Mid floor chilled units (Spider Units). The step is 300mm by 290mm in size and has routed slots on the base for airflow. The typical spider unit uses 9 steps per unit. Material - PETG 4MM Size – 300mm by 290mm Code: PET04



6 Facings deep upright pizza display. Material 5.0mm PTEG. Dims:150mmW x 435mmD x 135mmH. Code: PET-54



Artisan Display Props



Hessian Sacks for use in enhancement of Fruit and Veg displays. Big enough to fit around fruit and veg crates and give a perfect tidy and artisan looking display effect.

Size: 800mm X 1000mm Code: Hess 80x100

(If being used for unpackaged foods a food grade liner must be used)



Hessian Rolls for use in enhancement of displays. Hessian Material (Medium Grade (305GSM)) per 50 mtr Roll. Give your display a taste of the artisan look and feel.

Size: 1.83M by 50M Code: Hess Roll

(If being used for unpackaged foods a food grade liner must be used)



Wood wool is a great lightweight packing material - great for hamper, gift and retail display. 13.5 cubic foot approx. Lightweight & Eco Friendly solution. Code: WOODWOOL

(If being used for unpackaged foods a food grade liner must be used)



Sustainable Poly Display Crates

To use on side stacks or on shelf as part of a display.

The new generation RPC brings a softer look, while meeting sustainable criteria...

- Replace traditional wood crates with our new RPC's for a sustainable and hygienic solution
- Robust product protection during transportation
- Foldable and stackable to maximize space
- Active Lock system.
- Extra light weight for handling without the splinters or wires
- Environmentally friendly, fully recyclable
- Easy to clean polymer – resists moisture, insects and fungi; impervious to acids, fats, solvents and odours

Size : 600 x 400 x 163mm Code: 6416 Standard

Size : 400 x 300 x 163mm Code: 4316 Half



Smart Edge Crate Cover Baskets - The First Step In Adapting to the latest trends in produce presentation.

Available Brown Wicker Basket edge finishing.

- Create A More Premium Display.
- Highlight Sections, Organic Produce or Premium Ranges.
- Hygienic & Easy To Handle.
- Choice Of Finish, Black Food Safe Poly-Wicker for Crisp Product Popping Displays or Brown Wicker To Give A Powerful Ecological Appearance.

Ideal for creating a more premium display, while keeping in line with food safety standards. Designed to slip over standard fruit and veg Size 600 x 400 x 160mm H



Ideal for creating a more premium display, while keeping in line with food safety standards. Designed to slip over standard fruit and veg bale are cases.

Size: 600 x 400 x 160mm H

Brown Wicker

Code: BAS-A1 RATTAN

Black Poly-Wicker

Code: BAS-A1 BLACK



Black Poly-Wicker
Artificial
Material



Brown
Wicker
Artisanal
Material



NEW FORMAT Shelf Talkers

PVC Shelf Talker sleeve which slots into 39 high shelf edge front strip. Areas of use are, Front Of Store Fridge & Bakery Take Home Display.

Size: 115mm by 65mm

Code: PRET 03

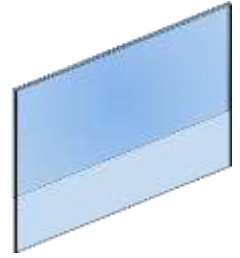

NEW FORMAT Serve-Over Shelf Talkers



MEAT & FISH COUNTER SPECIAL OFFER HOLDERS

2 pieces of 0.7mm PVC material that fit into each other, one flat & one with a fold. This make up allows for easier cleaning.

Size: 77mm high x 115mm long. PACKED IN BUNDLES OF 20

Code: PVC 56

Wooden Shelf Talkers Bakery A6 Wooden Shelf Talker



Birch Ply A6 Landscape or Portrait Shelf Talker Holder (sealed for food safety). Comes with back piece for inserting into SEL rails as shown (left). Open slot on side for inserting messages. Code: WOD 20P or WOD 20L



A6Plus Stand Options



Birch Ply A6 Table Top Holder. Can be used as shown for counter top, by inserting a leaning insert. High & Low options available and Open slot on side for inserting messages.

Standard L Code: WOD20+L

Tall (+ 80mm on L) Code: WOD20+TL



Craft Beer Wooden Shelf Talker



Birch Ply Craft Beer Shelf Talker Holder (sealed for food safety). Comes with back piece for inserting into SEL rails. (Chalkboard insert not inclusive) Open slot on top side for inserting messages. Overall size 170mm wide by 72mm high. Visible window size 146mm by 48mm. Code: WOD 22

Treat Holder Price Stand



Stand Alone Reverse Angled Black Stand, for use at front of store "Treat Display". (to the back of product)

Ticket Holder Size:
115mm x 65mm (High Angled Face)

Code:
HIP 02



Stand Alone wedge shaped Angled Black Stand, for use at front of store "Treat Display". (to the front of product)

Ticket Holder Size:
115mm x 65mm (Low Angled Face)

Code:
HIP 03

Shelf Talkers With Hinge

Hinged Shelf Talker for use with inserts that are printed in store.

Size: 1/3 A4 Code: WST 103 x 210 C
Size: 1/6 A4(6 up) Code: WST 77 x 153 C
Size: 1/4 A4 Code: WST 77 x 210
Size: 1/2 A4 Code: WST 106 x 297
Size: 106x270 Code: WST 106 x 270

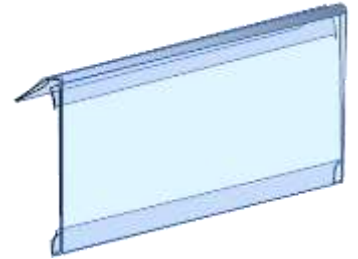

For width variations, please enquire with our office.

Shelf Talkers (Non Hinged)



PVC Shelf Talker with no hinge.
39mm reveal at top for fitting into shelf data strip.
1/3 A4 Code: DLST
A4 Portrait Code: STA4

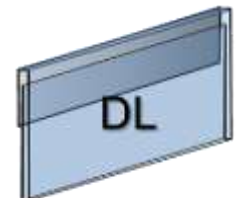

Bus Stop Clip

Bus Stop Clip Holder for holding shelf edge flag. Pack quantity 100. Code: BSC60 (Prints not included)



Freezer Shelf Talker

Shelf Talker which sits over freezer dividers to highlight special offers right at the Point Of Purchase. Size: 1/3 A4

Code: ST103x210 FREEZ

Fruit & Veg Talker

Shelf Talker which sits into F&V Angled Trays, highlighting special offers at the Point Of Purchase.

Size: 600mm by 105mm Message
Code: PVC 06



Shelf Fronts Main Floor Metal Shelving

RECOMMENDED One position clip on data strip, specially designed to accommodate variances of metal fronts for main floor Tego, Eden or RADFORD dry grocery metal shelving.

Length: 988mm Code: TER39-colour-988
 Length: 1238mm Code: TER39-colour-1238
 Colours: Clear, Cream, Light Silver

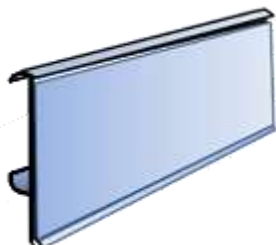
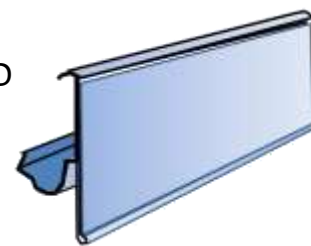

One position transparent clip on data strip, for main floor Tego, Eden style shelving dry grocery metal shelving. Colours: Clear & Dark Silver
 Length: 988mm Code: TEN39-clear-988
 Length: 1238mm Code: TEN39-clear-1238

Slide on data strip for Hansa Mertens Main Floor flat Metal shelving, Colour Silver

Code: MGW39/Silver/1187 Code: MGW39/Silver/ 987

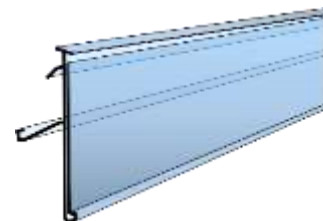

Shelf Edge Stick On Fronts

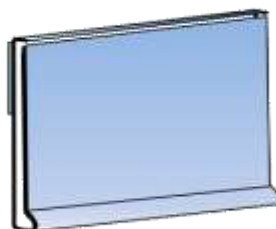

Stick on data strip for fridges and other areas, possibly Fruit & Veg

Length: 990mm Code: WSF39TP-Clear-990
 Length: 1240mm Code: WSF39TP-Clear-1240
 Length: 990mm Code: WSF39TF-White-990
 Length: 1240mm Code: WSF39TF-White-1240
 Length: 1240mm Code: WSF60TF-White/Clear-1240
 Length: 1240mm Code: WSF39/LS/FT-1240
 Tape: Foam tape (TF) / Clear Tape (TP)

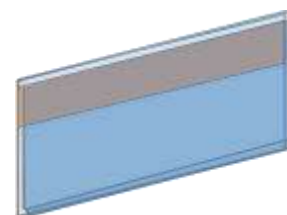

Shelf Fronts Fridges

White, clear, silver & Black - Clip on data strip for Linde Refrigeration Shelves, White replacement Clips are also available as below.

Length: 1240mm Code: TER39-colour-1240

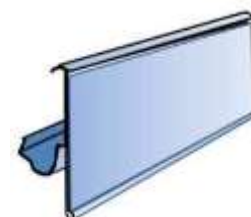

Clip for shelf edges on Linde Fridges. Used to attach data strip to Linde Refrigeration shelves. Colour: White Code: 9134691

Clear Data Strip with swinging hinge for fridges with oval bar front, use in Costan Fridges. Length: 1240mm Code: WC-CLEAR-1240

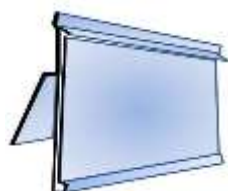

Data Strip for fridges with "C" Channel receiver, use in Chilled Fridges
 Length: 1240mm
 Colour: Clear/White
 Code: WVF39-colour-1240

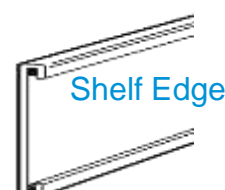

Shelf Edge Fronts Freezer Door Wire Shelves

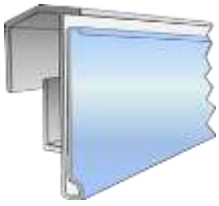

Clip Over data strip for Freezer Door wire shelves, colour white and label height for 39mm or less
 Length: 750mm Code: WBEG39-750
 Length: 590mm Code: WBEG39-590



"U" Shelf Front

Shelf Fronts For U Shaped Front

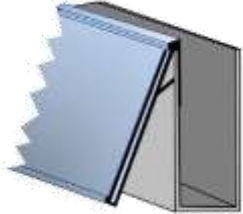

Clip over data strip 39mm high for use on any shelf that has an edge as shown in the drawing to the left.
 Length: 1240 Colour: Clear. Code: WRF39-1240

Coloured Shelf Edge Inserts

Shelf Edge Coloured Insert Rolls to suit 39mm high Data Strips. Colours as shown Black, Green & Red.

Code: Height/Length:
 ROLLS OF BLACK INSERT 39mm / 100 Meters
 ROLLS OF GREEN INSERT 39mm / 100 Meters
 ROLLS OF RED INSERT 39mm / 100 Meters

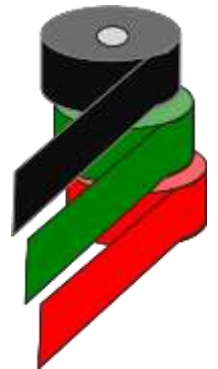

Acrylic Shelf Risers Main Floor

Biscuit Stop 30mm High (Shelf Riser) for Tego or Eden Shelving only. Material Acrylic

Length:	Code:
652mm	ACR 29
987mm	ACR 31
1237mm	ACR 30
537mm	ACR 46

30mm High Biscuit Stop



Shelf Riser 70mm High (Shelf Riser) for Tego or Eden Shelving only. Material Acrylic

Length:	Code:
652mm	ACR 34
987mm	ACR 32
1237mm	ACR 33

70mm High Riser

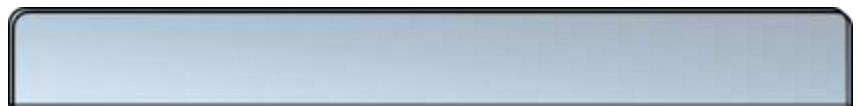

Acrylic Shelf Risers Refrigeration

Refrigeration Shelf Riser 105mm or 80mm High and 1250 Wide
 Material Acrylic . SUITS ALL 3,4 & 5 PIN SHELVES

Code: ACR 43 Size: 80mm H (above shelf) by 1250mm W
 Code: ACR 44 Size: 105mm H (above shelf) by 1250mm W

80mm or 105mm High Riser (above Shelf)

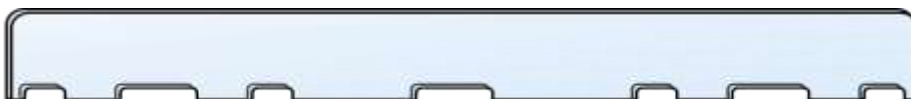

Imitation Cheese Props

Create Full Charcuterie displays without the continued cost of the extra stock. Effective displays promote impulse purchases, while reducing the risk of waste.

Imitation Grana Padano. Size: 210mm by 440mm
Diameter Code: CP-KD10337



Imitation Parmigiano. Size: 210mm by 440mm Diameter
Code: CP-KD10336



Imitation Fontina. Size: 60mm by 360mm Diameter
Code: CP-KD10352



Imitation Hollander. Size: 110mm by 150mm
Diameter Code: CP-KD10333

Imitation Toma. Size: 100mm by 370mm
Diameter Code: CP-KD10324



Imitation Piave. Size: 70mm by 300mm
Diameter Code: CP-KD10351

Imitation Parmesan with inside bowl. Size: Life Size Realistic
210mm by 440mm. Code: CP-KD10348



Imitation Cheese Cut Pieces. Size: Life Size Realistic 200mm by
450mm. Code: CP-KD17582



Imitation French Cheese Assorted. Size: Life Size Realistic 200mm
by 450mm. Code: CP-KD10350



Imitation Cheese Props

Create Full Charcuterie displays without the continued cost of the extra stock. Effective displays promote impulse purchases, while reducing the risk of waste.



Imitation Cheese Wheel Blue. Size: 40mm by 240mm
Diameter Code: CP-KD1043

Imitation Cheese Wheel Kernhem. Size: 55mm by 245mm
Diameter Code: CP-KD1016



Imitation Cheese Wheel Red. Size: 40mm by 240mm
Diameter Code: CP-KD1042

Imitation Cheese Wheel White. Size: 42mm by 248mm
Diameter Code: CP-KD1041



Imitation Castello Blue. Size: 53mm by 200mm Diameter
Code: CP-KD1023

Imitation Cheese Wheel Brie. Size: 39mm by 333mm
Diameter Code: CP-KD1004



Imitation Cheese Chaumes. Size: 45mm by 235mm Diameter
Code: CP-KD1009

Imitation Saint Albray. Size: 50mm by 250mm Diameter
Code CP-KD1008



Imitation Port Salut. Size: 60mm by 200mm Diameter
Code: CP-KD1006

Imitation Food Props

Create Full displays without the continued cost of the extra stock.
Effective displays promote impulse purchases, while reducing the risk of waste.



Green, Yellow or Red Peppers, (set of 3). Size: 85 x 110mm
Green Code: CP-KD07252 set of 3
Yellow Code: CP-KD07250 set of 3
Red Code: CP-KD07251 set of 3

Lemon Half X 3 set
Size: 40 x 35mm
Code: CP-KD01052



Bunch Of 6 Radish
Size: 35 x 130mm
Code: CP-KD07260



For Enquires on any other food prop products, please contact our office on 01 4587470 or send an email to sales@alliedpointofsale.ie



Imitation Parma Ham. Size: Life Size Realistic - 270mm by 480mm. Code: CP-KD12364

Imitation Salami White with Net, Set of 2.
Size:- 50mm by 250mm Code: CP-KD12372



Imitation Salami Red with Net, Size:- 50mm by 250mm Set of 2 Pcs. Code: CP-KD12373

Imitation White, Wine & Black Grapes .
Size: Life Size Realistic – 160mm Set of 6 pcs
White Code: CP-KD02104
Wine Code: CP-KD02106
Black Code: CP-KD02105



Green Leaf Garland. Size: 2000mm L
Code: CP-KD21672

Green Leaf & Lemon Garland.
Size: 2000mm length
Code: CP-KD21663



Parsley Garland.
Size: 2700mm length
Code: CP-KD21682



Garlic 20 pc Garland.
Size: 500mm length
Code: CP-KD20637



Imitation Fish Counter Props

Create Full Charcuterie displays without the continued cost of the extra stock. Effective displays promote impulse purchases, while reducing the risk of waste.



Lobster Prop. Size: 300mm by 130mm Code: CP-KD13402

Crab Prop. Size: 200mm x 130mm Code: CP-KD13423



Imitation Shells pack of 4 .Size: 120mm Code: CP-KD13410

Imitation Mussel String. Size: 350mm Code: CP-KD19616



Imitation Shell String. Size: 350mm Code: CP-KD19615

Imitation Trout String. Size: 350mm Code: CP-KD19627



Imitation Sardines String. Size: 350mm Code: CP-KD19624

Fishing Net Prop with 13 fish. Size: 2000mm by 1500mm Code: CP-KD13448



Creel Net Prop. With 8 fish. Size: 470mm Code: CP-KD13447



Mini Assorted Fish Props. Number of pieces 24. Sized from 70mm to 120mm Code: CP-KD13458



Versatile, Eye-catching, high impact Feature Display Table.

Ideal for creating a rustic or premium look & feel to any product range, promoting impulse purchasing.

MINI Mid Floor Feature Display Table. Each Table comes with four 200mm D shelves by 665mm W & 1 by Goal Post Graphic holder (sign not included) . Shelves can be mounted to the front, back, sides or below Graphic on Goal Post. Finish is black powder coated on all metal parts & legs are fitted with self levelling feet. Unit Dimensions not inclusive of shelves H 1470mm x W 665mm x D 665mm Note - Shelves in situ, increase dims by 200mm on each side. Complete Table with 4 shelves, Goal Post with 2 hooks to hold sign & wood top
Code: TB 665 COM

Standard



Standard Set as per image on the left..... If you would like to explore other options as shown on the right, contact our office for further details.

Modified



Standard



MAXI Mid Floor Feature Display Table. Each Table comes with four 200mm D shelves by 1000mm W, 1 by 665 shelf x 200 D & 1 by Goal Post Graphic holder . Shelves can be mounted to the front, back, sides or below Graphic on Goal Post (sign not included). Finish is black powder coated on all metal parts & legs are fitted with self levelling feet. Unit Dimensions not inclusive of shelves H 1470mm x W 665mm x D 1025mm Note - Shelves in situ, increase dims by 200mm on each side. Optional Add-On of front table with 3 shelves, can be used to extend the display when busy and reduce the display when stocks are low..

Complete Table Set

Code: TB 665-1000 COM + TB - SMALL

MAXI SET



Small stand can be tucked under front display when stock reduces



MAXI SET





Banana Tree

Banana Tower with 5 tiers of 5 hooks & one tray
 500mm D, for displaying bananas while minimising
 product damage. Size: H 1900mm (including the
 show card holder) W 605mm D 400mm
 Colour Black RAL 9005- Code: 197509



The Adaptable – Floor Stand



Adaptable Feature Display. Three angled shelves that can be
 used to hold multiple inserts Latted Crates, Poly Crates or
 Poly Wicker Baskets. Totally adaptable to suit all store
 environments and a wide range of products .Stands Sold
 separately and then choose your crates or baskets to suit
 your requirements. Size: H 1200mm W 650mm D 400mm
 OAK Finish - Code: BX-OAK
 PINE Finish - Code: BX-PINE



Poly Crates Page 23



400 by 600
1 per shelf



300 by 400
2 per shelf



Latted Crates Page 46



300 by 400
2 per shelf

400 by 600
1 per shelf



Poly Wicker Baskets Page 34



Table Top *Multi* Tier Displays

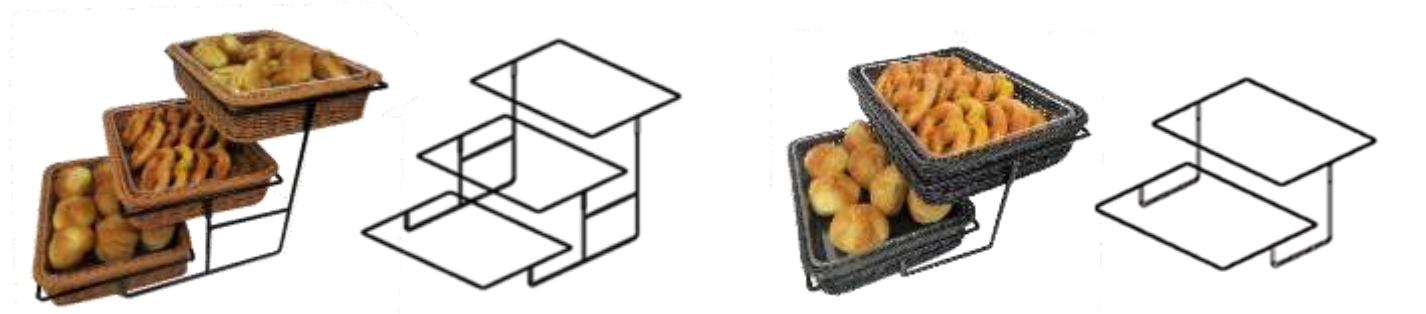

Powder Coated Black Metal Frame Stand, supporting stepped Poly-wicker food safe display. Display will help promote additional sales while adding perceived value to your offering. Could also be used as a centre piece table display for highlighting seasonal offers or featured products. Chestnut colour Poly-wicker with Black powder coated frame.

3 Tier Large: H 380mm x W 400mm x D 620mm -
2 Tier Large: H 220mm x W 400mm x D 480mm -

Code:TC-019
Code:TC-019-B

Get Creative With Tier Displays



Poly Wicker Display Baskets

Chestnut Brown Poly-wicker baskets are food-safe, dishwasher-proof and suitable for use in chilled cabinets. Comes with a hand washable food safe liner. Size: 70mm H x 400mm by 300mm Code: PLO25



Black Poly-wicker baskets are food-safe, dishwasher-proof and suitable for use in chilled cabinets. Comes with a hand washable food safe liner. Size: 70mm H x 400mm by 300mm Code: PLO26



Basket Liner Replacements. For above baskets and Latted Crates on page 46 – WS690. Hand washable food safe liner. Material PETG. Size: 70mm H x 400mm by 300mm Code: PETG LINER



Hygienic cover for counter-top Poly-wicker baskets. This cover is designed specifically to fit the counter-top baskets above. The cover is made from a food safe durable material. Standard & opening roll-top versions available. Standard Code: PC-007 Roll-top Code: PC-005



Clear Clamp for use with standard frames. Can be clipped onto the wicker baskets as shown. Could also be used with a chalk board insert for a more Artisan look & feel. Frame & Insert are not included but can be found with Frame Accessories. Code: 9173219



Counter Stand 3 Tier

One 3 Tier stand – Many Combinations. Versatility to hold food safe Lined Poly Wicker Baskets, Food Safe Lined Wood Trays or food safe Melamine Platters. Construction - Metal-framed 3 tier display. Height: 380mm Width: 400mm & Front to Back: 700mm Stand Only Code: MET 71



Optional Current products that can be used in conjunction with the 3 Tier stand....listed below



Inspiration Use Stackable Crates To Build Tiers

Stackable Crates to create tiered displays. Natural Finish.
Size: 400x300x100mmH. Single Crate Code: WS 690
Crate also shown on Page 46

Food Grade
Infill Liner
Available



Display Risers

Wire Cube Riser for product displays. For use with all platters, plates, or slate boards. Ideal for creating tiered presentation within serve-over or on feature displays. Dimensions 109mm H x 179mm x 168mm. The sizing allows for the riser to be used with all platters within this catalogue. The riser is coated with black nylon to help with non slip locating of platters.

Code: MET 72



Milking Stool Tiered Displays Sets

Wooden milking display stool sets, designed to enhance product displays, in a natural finish: Sizes/Heights in set. 100 (S), 150 (M) & 200mm (L) high. Tops made from 18mm Ply with a diameter of 300mm 4 Legs for extra support. 25mm Dia. Unstained,

Natural Finish Set of 3 Code: WS623

Rustic Brown Set of 3 Code: WS623RB

(If being used for unpackaged foods a food grade liner must be used)



Melamine Large Round Platter for above display stools. This food safe platter is self locating to the display stools as a round ridge on the base of the platter fits over the circumference of the stool top. Size: 350mmD by 20mm H. Colour: White
Code: MELKUL 1000035

Mini Pallet Displays Sets

Mini Display Pallets –ideal for displaying food on a counter top! 3 sizes in set. Small - 265 x 163 x 70mm Medium - 325 x 265 x 70mm Large - 354 x 325 x 70mm. Made from raw wood (Pine) Perfect for shop displays.

Natural Finish Set of 3 Code: WS613

Rustic Brown Set of 3 Code: WS613RB

(If being used for unpackaged foods a food grade liner must be used)



A Frame 3 Tier Floor Stand

Rustic wooden ladder display is perfect for product feature displays, or product high lighting. Overall height is approx. 1400mm and shelves are 1000mm, 750mm & 500mm x 400mm Deep.

Chunky Pine Board, with easy to remove shelves. The frame folds up for easy storage when not in use. Picture is White Wash finish, also available in Natural & Dark Oak, please enquire to sales team in our office on 01-4587470 for further details.

White Code: WC605-WW

Dark Oak Code: WC605-D

Natural Code: WC605

(If being used for unpackaged foods a food grade liner must be used)



Presentational - Food Safe Display

Melamine Display Frying Pan.
 Finish White Granite or Black Matt.
 White Granite Size: 240mm D by 410mm L.
 Code: 38024WG
 Black Matt Size: 240mm D by 410mm L.
 Code: 38024B



Colour, Cement.
 Code: 530636

Display/Serving Platter. Material
 Melamine & Size 440mm by 305mm.

Colour, Turquoise Cherry.
 Code: 530637



Melamine Wood Effect Handled
 Rectangular Presentation Platter.
 Finish as shown, Walnut.
 Size: 500mm by 195mm
 Code: 35040-col



Walnut



Melamine Wood Effect Round
 Presentation Platter. 330mm by
 300mm. Material Melamine.
 Code: 35033



Melamine Wood Effect Oval
 Presentation Platter. 530mm by
 270mm Code: 35053



Collection Details



Melamine Display Bowls – Salad Bar



Melamine Large Bowl 330mm D x 100mm H
WHITE TRANSFORM Code: 530647



Melamine Medium Bowl 255mm D x 80mm H
WHITE TRANSFORM Code: 530646

Melamine Platter 280mm by 190mm RECTANGULAR
PEBBLE ENDURE Code: 529790



Slate Effect Melamine Display Platters



Sierra or Black Slate Effect Round Melamine Platter.
Food Safe, Hard Waring & Dishwasher Friendly
Size:300mm D by 10mm H
Colour: Black Code: 47030BL
Colour: Sierra Code: 47030SI



Sierra or Black Slate Effect Square Melamine Platter. Food
Safe, Hard Waring & Dishwasher Friendly
Size:300mm by 300mm by 10mm H
Colour: Black Code: 47230BL
Colour: Sierra Code: 47230SI



Sierra or Black Slate Effect Rectangular Melamine Platter.
Food Safe, Hard Waring & Dishwasher Friendly
Size:325mm by 162mm by 10mm H
Colour: Black Code: 47013BL
Colour: Sierra Code: 47013SI



DELI POS – Melamine

Condiment Holders

Round Black Melamine
Condiment Bucket Holder
Food Safe, Hard Waring &
Dishwasher Friendly



Code: MELKUL48008.BL Black
Code: MELKUL48011.BL Black
Code: MELKUL48015.BL Black

76mm D by 85mm H (140ml)
110mm D by 93mm H (430ml)
150mm D by 110mm H (1100ml)



Round Grey Melamine
Condiment Bucket Holder
Food Safe, Hard Waring &
Dishwasher Friendly



Code: MELKUL48008.G Grey
Code: MELKUL48011.G Grey
Code: MELKUL48015.G Grey

76mm D by 85mm H (140ml)
110mm D by 93mm H (430ml)
150mm D by 110mm H (1100ml)



DELI POS – Natural Slate & Tasting Units

Slate Platter with metal handles. Promote High margin products in style. Ideal for displaying or serving cheeses and other foods.

H:25mm W:250mm L:350mm

Code: SP211



Two Tiered Round Natural Slate Platter. Treated to be completely food-safe and washable so you can display cakes, cheese, cooked meats and other produce with style and elegance.

H: 240mm D: 250mm Code: SP210



Natural Slate Board With Rope. Create the signs you need when you want them and hang them where they will have the most effect.

Size: Height: 80mm x Width: 120mm Code:SP207

Heart Shape Size: H: 70mm W: 65mcm Code:SP208

Rectangle



Tasting Units



Food Sampling Unit - Clip On Tray.
Dimensions 215mm W by 195mm D by 335mm H
Code: ACRFSU-CLIPON

Food Sampling Unit - Stand.
Dimensions 215mm W by 195mm D by 335mm H
Code: ACRFSU COUNTER STAND



Food Sampling Stand, complete with holders for Napkins, Brochure Holder(DL), Toothpick Holder & Waste Bin. There is a 380mm diameter Dome Cover & Stainless Steel Tray. Colour is silver grey powder coated finish. Dimensions 400 D by 1200 H. The below cost does not include branded prints. Code: 57.0110.1

To Order Just the Top Dome - Roll - Top Hemisphere cover for Food Sampling Stand
Code: 57.0121.1

On The Menu

Copper Mesh Menu Holder & Clip



Self Standing Portrait Angled Menu Holders, Polished Copper Mesh finish with matching clip. Slightly oversized to give the full effect of the premium menu holder.

Size: A4 Code: CMA4
Size: A5 Code: CMA5



Chalk Pen & PVC Black Board Tickets

Stand Alone Angled PVC Black Board, for use in the serve over. There is a built in base (45mm deep) which acts as the stand. For use with chalk Marker Pens in catalogue.

Size: 75mm x 75mm(Angled Face) Code: 8311 75x75L



PVC Marker Black Board ticket for use in the chilled serve over. Other sizes available on request. For use with chalk Pens.

Size: 60 x 70mm Code: 8311 60x70
Size: 60 x 90mm Code: 8311 60x90

Chalk Black Board Adhesive Tickets

Securit® Rectangle Chalkboard stickers - Set of 8

Dims: 47x80x0.04mm

Code: Sec-CS-RECT-8



Securit® Oval Chalkboard stickers - Set of 8

Dims: 47x80x0.04mm

Code: Sec-CS-OVAL-8



Securit® Waterproof chalk marker white or coloured (Red, Green, Yellow & Blue) For use on Glass or Chalkboard. 2-6mm nib - Sets of 4

White Code: Sec-SMA610-V4-WT

Coloured Code: Sec-SMA610-V4

Securit® Waterproof chalk marker white or coloured (Red, Green, Yellow & Blue) For use on Glass or Chalkboard. 7-15mm nib. Sets of 4

White Code: Sec-SMA820-V4-WT

Coloured Code: Sec-SMA820-V4



Poster Pen Cleaner – Transparent bottle with spray nozzle for ease of use when wiping poster pen from black boards.

Size: 750mm Code: Sec-CLEAN-GR



Securit® Magic cleaning sponge - Set of 2

Dims: 25x60x105mm

Code: Sec-SPONGE-2



Serve Over Pricing

Stainless Steel

Stainless steel stand - with ring top holder base plate 80x68mm - thickness 1mm total
55, 105 & 155mm height options

Height 55mm Code: DELI 25
Height 105mm Code: DELI 26
Height 155mm Code: DELI 27



Deli Spike SS / Price Card Holder
Stainless Steel spike with ring holder for laminate cards.
Size 100mm high.
Code: SS DELI SPIKE



Stainless Steel ring top holder for price card for laminate cards.
50mm base & 100mm high
Code: SSDELIRING50



40mm high Stainless Steel Deli Stand Price angled spring Clip Top Price Card Holder. Can be used with laminate cards or PVC Chalk Boards in Serve Over.
Height: 40mm Code: DELI 28

90 mm high Stainless Steel Deli Stand Price angled spring Clip Top Price Card Holder. Can be used with laminate cards or PVC Chalk Boards in Serve Over. Height: 90mm
Code: DELI 29



Stainless Steel Deli Bowl Clip Price Card Holder with adjustable angle top grip holder. The Holder can be used with laminate cards or PVC Chalk Boards in Serve Over Counter.
Code: DELI 30

Stainless Steel Deli Clip Price Card Holder angled top grip ring holder. Can be used with laminate cards or PVC Chalk Boards in Chilled Serve Over Counter or hot counter. Code: SS DELI RING CLIP



HOT FOOD COUNTER Black Board Tickets

Heat Resistant Black Board ticket for use in the Hot Counter serve over (holds consistency with constant heat up to 100 degrees & is Food Safe Standard Material. For use with Chalk Pens & SS ticket holders above.

Size: 96 x 96mm Code: 8311HOT 96x96
Size: 85 x 55mm Code: 8311HOT 85x55

For Printed Hot Ticket Versions, Please contact our office on 01-4587470 , with your enquiry.



Treat Holder Price Stand



Stand Alone Reverse Angled Black Stand, for use at front of store "Treat Display". (to the back of product)
 Ticket Holder Size: 115mm x 65mm(Angled Face)
 Code:HIP 02

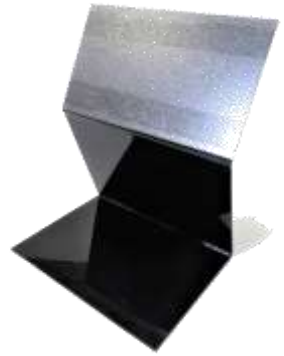

Stand Alone wedge shaped Angled Black Stand, for use at front of store "Treat Display". (to the front of product)
 Ticket Holder Size: 115mm x 65mm(Angled Face)
 Code: HIP 03

Serve Over Pricing

Deli Stand, Price Card Holder stand with grip top holder for laminate cards. Both base and top holder swivel for use at different angles.
 Size: 100mm Code: DELI 07



Deli Stand with block base. Price Card Holder stand with crocodile clip top for holding Chalk Boards or card type signs.
 Size: 110mm High Code: DELI BLOCK

Deli Stand with Small Clamp Top & Swivel Stem with centred round base
 Size: 50mm (H) Code: DELI 06
 Colour: Black



Clip On Ticket Holders

Basket Clip



Midi Bowl clip, available in Black & also in White.
 Dims: 55x10x2mm. Black Code: DELI 12
White Code: DELI 14



Swivel Clamp Holder with Grip attachment. For use in Bread area with clamps going over baskets. Top grip holds laminate card to accommodate pricing. Colour: Transparent
 Code: 9217857

Serve Over Pricing

Clear & Black



Deli Clip with Grip Top for laminate card thickness. Colours available Black & Clear. Size:

	Colour:	Code:
50mm	Clear	P24000
50mm	Black	P24000BO1R



Deli Clip with Clamp Top for laminate card or chalk board thickness. Colours available Black & Clear. Size:

	Colour:	Code:
50mm	Clear	P23001
50mm	Black	P23001BO1R



Deli Stand clear polycarbonate all one piece for use in conjunction with laminate card for pricing. Size:

	Colour:	Code:
110mm H	Clear	DS - 110
80mm H	Clear	DS - 80
80mm H	Black	DS - 80 BLACK
30mm H	Clear	DS - 30



Flat Deli Stand with Angled Grip Top for laminate card or chalk board thickness. Colour Black. Size:

	Colour:	Code:
20mm (H)	Black	DELI 15



Clip On Ticket Holders

Securit® Clip tag holder - set of 6 (tags not included)
 Dims: 55x10x2mm. Code: Sec-TAG-HLD-CP



Fish Serve Over Pricing & Promotion

Ice Spike, Price Card Holder spike with clamp top holder for laminate cards or chalk board inserts. Swivel function holder for adjustable angles. Holds material thickness up to 3mm. Size: 150mm breakable to 100mm.

Colour: Transparent Code: 28433 - 00

Transparent Ice Spike, Price Card Holder spike with grip top holder for laminate cards or chalk board inserts. This is a one piece value solution with one position only, for holding laminate cards or PVC chalk boards below, material thickness up to 1.0mm
 Size: 175mm Code: 9470845



Wine Displays & Bottle POS



Mini Wine Display Tower The circular design gives this tower great flexibility and full 360° access. Available in various finishes. Supplied ready to merchandise. Colour Black.

Shelf sizes: 2 x Ø450mm & 2 x Ø550mm.
Overall size: Ø550mm x H 1500mm .
Code: 173225



Wine "Zig Zag" Bottle Display Rack. Eye-catching wall display, to highlight product or create atmosphere to overall look & feel of your off-licence. Holds 6 bottles. Size: H 825mm W 320mm D 110mm Code: BX-081



Off-Licence Bottle Shelf Talkers & High-Lighters

Wine Bottle Talker

A Bottle Neck Talker that can take a printed insert. Insert size is 90mm high by 75mm wide. The folded top has a hole which sits over the bottle top to hold the bottle talker in place. Material - PVC
Code: WINEBOTTLE ST



Securit® Table or counter Bottle displays with chalkboard frames – to hold 1 or 3 bottles.

1 bottle Code: Sec-WB-WR-1 Dims:450 x 110 x 113mm
3 bottle Code: Sec-WB-WR-3 Dims:450 x 390 x 113mm



Securit® Bottle neck hanger in oval shape - Leather cord with chalk marker included - set of 6. Dims: 50 x 83 x 20mm
Code: Sec-TAG-BOTTLE



Securit® Bottle neck chalk board tag - set of 10
Dims: 50 x 83 x 20mm
Set of 10 Code: Sec-TAG-BO-WT



Wood Crate & Barrel Display

Wine Crates, the traditional 12 bottle crate, for perfectly tidy bottled wine displays. Size: 500x330x170 Code: WINECRATE
(If being used for unpackaged foods a food grade liner must be used)



Wooden display barrels are a perfect way of adding a rustic look to your store. The circular design gives this barrel full 360° access to your promotions. Manufactured from 18mm MFC supplied with wire riser and 70mm price label holders ref.3742.

Finish: Oak Size: 672mm x H 985mm.

Made to order, lead time on request.

Code: 173197

Wine Barrel with 1 shelf, stained with black bands and Matt varnish. Approximate Size: 940mmH x 650mmD

Code: WBS

(If being used for unpackaged foods a food grade liner must be used)



Short Half Whiskey Barrel with 1 shelf, stained with black bands and Matt varnish. Approximate

Size: 900mmH x 650mmW x 325D Code: WBS HALF

(If being used for unpackaged foods a food grade liner must be used)

Long Half Whiskey Barrel with 1 shelf, stained with black bands and Matt varnish. Approximate

Size: 900mmH x 650mmW x 325D Code: LHWBS

(If being used for unpackaged foods a food grade liner must be used)



Half Barrel Hourglass Display, stained with black bands and Matt varnish.

Approximate Size:

Large H780xD550

Medium H640xD470

Small H580xD370

(If being used for unpackaged foods a food grade liner must be used)

Code:

HBH Large

HBH Med

HBH Small

Half Barrel Trough Display, stained with black bands and Matt varnish.

Approximate Size:

Large H390xD550

Medium H320xD470

Small H290xD370

(If being used for unpackaged foods a food grade liner must be used)

Code:

HB Large

HB Med

HB Small





Softwood Display Crate. Size: 400 x 300 x 90mm H
Designed for stacking/nesting with each other, or 2
to nest with WS689 (below) Code: WS 690

(If crates are being used for unpackaged foods a food grade liner must be used)



Softwood Display Crate. Size: 600 x 400 x
150mm H Designed for stacking/nesting
with each other. Code: WS 689

(If being used for unpackaged foods a food grade liner
must be used)



Large Shelved Rustic Crate

Portrait



Now comes with a shelf making it perfect for shop displays, to
feature or highlight products. Material is 8mm rough sawn
Scandinavian pine. Crate size: W 500mm x D 370mm x H 260mm.
The colour finish is Rustic Brown and there are two shelf options
with landscape or portrait variants.

Landscape Shelved

Code:WTC170L

Portrait Shelved

Code:WTC170P



Landscape

Create Your Own Unique Displays Using The Crate Bundles...

Mixed Bundle Rustic Crate

pack makes for fantastic displays. Shop floor or window
display - you name it they'll look the part. Pack consists of a
Medium, Large & Extra Large Crate. External sizes: D 255mm
x W 350mm H 250/500/750mm. Made from three 8mm thick
fine-sawn Scandinavian pine slats (60mm). Bases stained
white as standard, finish is rustic oak colour as standard. For
a secure and safe display, crates can be screwed together
and/or fixed to a wall.

Bundle pack of three crates.

Code: WTC212



Standard
Bundle Pack



3 Bundle packs
needed to
create the
above display

Large Crate Bundle



These rustic oak finished crates as above are recommended for featured
product displays. Useful for floor, window or wall displays. This bundle pack
consists of 6 large crates, made from 8mm Scandinavian pine slats, with a 6mm
white ply backing. We would always recommend screwing crates together to
secure display. External crate sizes: D 255mm x W 350mm H 500mm

6 Crate Bundle

Code:WTC214G

Artisan Display

Large Rustic Wooden Crates. These replica antique crates were originally manufactured to transport fruit, but are now seen as fantastic shop displays. These rustic oak stained crates come with the following spec: Sides & base made from 8mm rough-sawn Scandinavian pine slats. Plain as standard but Printing available (POR)

Size: Large 500mm wide x 370mm deep x 260mm high. Code: WTC106

Size: Medium 425mm wide x 310mm deep x 230mm high. Code: WTC106M

(If being used for unpackaged foods a food grade liner must be used)



Large Rustic Tray with Handles. This single slat rustic tray has been based on the original fruit "keepers" tray. Sides & base made from 8mm rough-sawn Scandinavian pine slats. Sizes: W 500 x D 365 x H 85mm & available in Rustic Brown, Pale Blue, Sage Green or White Wash.

Rustic Brown Code: WTC152RB

Pale Blue Code: WTC152PB

Sage Green Code: WTC152SG

White Wash Code: WTC152WW

(If being used for unpackaged foods a food grade liner must be used)



Medium Rustic Planter Crates with Handles. Planter crates are based on the traditional apple or "bushel" crate & are ideal for retail display. Sides & base made from 8mm rough-sawn Scandinavian pine slats with hand holes on short sides. External Sizes: W 400 x D 310 x H 170mm & available in Rustic Brown, Pale Blue, Sage Green or White Wash.

Rustic Brown Code: WTC113RB

Pale Blue Code: WTC113PB

Sage Green Code: WTC113SG

White Wash Code: WTC113WW

(If being used for unpackaged foods a food grade liner must be used)



Large Rustic Planter Crates with Handles. Planter crates are based on the traditional apple or "bushel" crate & are ideal for retail display. Sides & base made from 8mm rough-sawn Scandinavian pine slats with hand holes on short sides. External Sizes: W 520 x D 370 x H 290mm & available in Rustic

Brown, Pale Blue, Sage Green or White Wash.

Rustic Brown Code: WTC115RB

Pale Blue Code: WTC115PB

Sage Green Code: WTC115SG

White Wash Code: WTC115WW

(If being used for unpackaged foods a food grade liner must be used)



Slatted Rustic Crate

Slatted Rustic wooden crate is a great alternative to any retail shop displays. Extra Slat can be used for branding or just simply as a riser for bagged product or loose product displays. Finish is rustic brown and material is 8mm Scandinavian pine. Ideal Crate for stack displays.

Code: WTC106ST

(If being used for unpackaged foods a food grade liner must be used)



Table Chalkboard Accessories



Securit® Mini Table Sandwich Writable Sign, including chalk marker - set of 5 – Dims: 85 x 5 x 5mm
Code: Sec-TAG-SBS-WT



Securit® Mini table chalkboard / Poster Holder - Plain lacquered wood. Dims: 250 x 152 x 20mm
Code: Sec-SBS-B-MNI

Securit® Mini Easel table chalkboard - pack of 3 - Wood with lacquered black or Beech finish, with melamine chalkboard, Set of 3 pieces.

BLACK Dims: 244mm by 150mm by 135mm

Code: Sec-MNI-BL-KR set of 3:

BEECH Dims: 244mm by 150mm by 135mm

Code: Sec-MNI-B-KR set of 3:



Securit® Teak tag holder, including chalkmarker and A7 tags - Wooden - set of 6 - Size: 90mm x 105mm x 30mm
Code: Sec-TAG-HLD-TE



Securit® Silhouette rectangle mini chalkboards, including chalkmarker – Wooden base - set of 4 - 7,5x9x2cm | 0,1kg
Code: Sec-FBT-RECT-4



Securit® Chalkboard tag sets in sizes A4, A5, A6 & A7 including chalkmarker, 4 spikes - and 2 transparent holders

A4 Set of 5 Dims: 297 x 210 x 1mm

Code: Sec-TAG-A4-WT

A5 Set of 10 Dims: 210 x 148 x 1mm

Code: Sec-TAG-A5-WT

A6 Set of 20 Dims: 143 x 105 x 1mm

Code: Sec-TAG-A6-WT

A7 Set of 20 Dims: 105 x 74 x 1mm

Code: Sec-TAG-A7-WT



Securit® Spike tag holder - set of 20 (tags not included)
Dims:50 x11x 10mm Code:Sec-TAG-HOLDER-BL

Securit® Transparent tag holder - Acrylic - set of 10 (tags not included)
Dims:10 x 40 x 6mm Code:Sec-TAG-HOLDER-TR



Securit® Vertical L-shaped A5 table chalkboard. Frosted front with a gloss back - set of 3

A5 Set of 3 - Dims: 215 x 158 x 50mm Code: Sec-TBA-BL-A5

A6 Set of 3 - Dims: 155 x 105 x 50mm Code: Sec-TBA-BL-A6

Securit® Vertical L-shaped A6 table chalkboard. Frosted front with a gloss back - set of 5

A7 Set of 5 - Dims: 115 x 75 x 50mm Code: Sec-TBA-BL-A7

A8 Set of 5 - Dims: 70 x 75 x 50mm Code: Sec-TBA-BL-A8



Pavement Boards - *Deluxe*



Securit® Sandwich hard wood pavement chalkboard with lacquered rubberwood frame.
 Dims: 850mm x 555mm x 545mm | 7,1kg
 Teak finish.
 Code: Sec-SBD-TE-85



Securit® Sandwich hard wood pavement chalkboard with lacquered rubberwood frame. Dims: 1250mm x 705mm x 570mm | 13,8kg
 Teak finish.
 Code: Sec-SBS-TE-120

Pavement Boards - Woody

Securit® Duplo pavement chalkboard with lacquered pinewood frame. Finish Black or Teak.

850mm x 545mm x 440mm Black

Code: Sec-SBD-BL-85

850mm x 545mm x 440mm Teak

Code: Sec-SBDW-TE-85

1250mm x 690mm x 565mm | 8,3kg Black

Code: Sec-SBS-BL-120

1250mm x 690mm x 565mm | 8,3kg Teak

Code: Sec-SBSW-TE-120



Pavement Boards - Nature



Securit® Sandwich pavement chalkboard with lacquered soft wooden frame with a rustic, natural finish. Colours, Natural or Vintage Grey, Scaffold Wood. 2 Available sizes 85cm & 135cm.

Finish Scaffold Wood. Dims: 850mm x 545mm x 440mm | 4,7kg
 Code: Sec-SBS-N-85

Finish Vintage Grey. Dims: 850mm x 545mm x 440mm | 4,7kg
 Code: Sec-SBS-NG-85



Finish Scaffold Wood. Dims: 1310mm x 722mm x 720mm | 11,6kg

Code: Sec-SBS-N-135

Finish Vintage Grey. Dims: 1310mm x 722mm x 720mm | 11,6kg

Code: Sec-SBS-NG-135



Table Chalk Boards *Elegant*



Securit® Elegant large table chalkboard - Wood with lacquered black or Teak finish, with melamine chalkboard inserts, A4, A5 & A6 portrait.

BLACK A4 Dims: 323mm by 271mm by 70mm

BLACK A5 Dims: 240mm by 200mm by 60mm

BLACK A6 Dims: 174mm by 157mm by 50mm

Code: Sec-ELE-BL-LA

Code: Sec-ELE-BL-ME

Code: Sec-ELE-BL-SM



TEAK A4 Dims: 323mm by 271mm by 70mm

TEAK A5 Dims: 240mm by 200mm by 60mm

TEAK A6 Dims: 174mm by 157mm by 50mm

Code: Sec-ELE-TE-LA

Code: Sec-ELE-TE-ME

Code: Sec-ELE-TE-SM

Securit® Elegant large table chalkboard - Wood with lacquered black or Teak finish, with removable transparent frame to insert pages. A4, A5 & A6 portrait.

BLACK A4 Dims: 323mm by 271mm by 70mm

BLACK A5 Dims: 240mm by 200mm by 60mm

BLACK A6 Dims: 174mm by 157mm by 50mm

Code: Sec-PFT-BL-LA

Code: Sec-PFT-BL-ME

Code: Sec-PFT-BL-SM

TEAK A4 Dims: 323mm by 271mm by 70mm

TEAK A5 Dims: 240mm by 200mm by 60mm

TEAK A6 Dims: 174mm by 157mm by 50mm

Code: Sec-PFT-TE-LA

Code: Sec-PFT-TE-ME

Code: Sec-PFT-TE-SM



Table Chalk Boards *Silhouette*



Securit® Silhouette cup chalkboard, including chalk marker – Wooden base . Dims: 213mmx335mmx60mm

Code: Sec-FBT-CUP

Securit® Silhouette cup chalkboard, including chalk marker - Wooden base. Set of 3 Mini - Dims: 90 x 135 x 20mm Code: Sec-FBT-CUP3



Securit® Silhouette menu table chalkboard, including chalk marker - Aluminium base Dims:342 x 210 x 60mm Code: Sec-FBTA-MENU

Securit® Silhouette menu table chalkboard, including chalk marker - Aluminium base Dims:345 x 210 x 60mm Code: Sec-FBTA-COCKTAIL



Securit® Silhouette menu table chalkboard, including chalk marker - Aluminium base Dims:345 x 230 x 60mm Code: Sec-FBTA-WINE

Securit® Silhouette menu table chalkboard, including chalk marker - Aluminium base Dims:240 x 340 x 60mm Code: Sec-FBTA-PIZZA



Chalk Boards *Silhouette*



Securit® Silhouette A4 table chalkboard, including chalk marker - Aluminium base.
Dims: 308x210x60mm
Code: Sec-FBTA-A4



Securit® Silhouette chef table chalkboard, including chalk marker - Aluminium base. Dims: 345x220x60mm
Code: Sec-FBTA-CHEF



Securit® Silhouette arrow chalkboard sign - Including wooden stand with spike and a chalk marker. Dims: 670x492x2mm
Code: Sec-FBS-ARROW



Securit® Silhouette Sandwich chalkboard, including chalk marker - Aluminium base. Dims: 240x340x60mm
Code: Sec-FBTA-SANDWICH

Securit® Silhouette rectangle chalkboard sign - Including wooden stand with spike and a chalk marker. Dims: 735x450x2mm Code: Sec-FBS-RECTANGLE



Securit® Silhouette bubble chalkboard tags, including chalk marker - set of 5
Dims: 180x81x1mm Code: Sec-TAG-BUBBLE-5



Securit® Silhouette glass chalkboard - including chalk marker and self adhesive mounting strips.
Dims: 500x235x3mm
Code: Sec-FB-GLASS



Securit® Silhouette rectangle chalkboard tag, including chalk marker - set of 5. Dims: 180x80x1mm
Code: Sec-TAG-RECTANGLE-5



Securit® Silhouette bottle chalkboard - including chalk marker and self adhesive mounting strips. Dims: 497x195x3mm
Code: Sec-FB-BOTTLE



Securit® Silhouette bubble chalkboard - including chalk marker and self adhesive mounting strips. Dims: 273x470x3mm
Code: Sec-FB-BUBBLE



Securit® Silhouette cup chalkboard - including chalk marker and self adhesive mounting strips. Dims: 283x445x3mm
Code: Sec-FB-CUP



Securit® Silhouette glass chalkboard - including chalk marker and self adhesive mounting strips. Dims: 298x377x3mm
Code: Sec-FB-OVAL

Something Different



Securit® Hexagon cork- & chalkboards - including chalk marker, pins and double sided tape mounting strips - set of 7 pcs (4x chalkboard + 3x cork) –
Each Dims: 200x230mm
Code: Sec-FB-CB-HEX

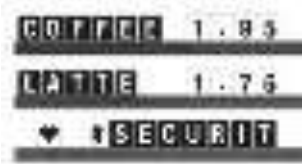

Securit® XXL Square Chalkboards - set of 6 Dims: 400x400x2mm
Code: Sec-FB-XXL



Securit® Letter Shelf, including 169 double sided paper cards with letters, numbers and icons.
Dims: 25x250x2mm
Code: LESec-S-BL-100



Securit® Window poster frame - Double sided and UV resistant - 4 suction cups included –
A4. Dims: 360x271x2mm
Code: Sec-PFW-A4-BL



Securit® Window poster frame - Double sided and UV resistant – 4 suction cups included –
A3. Dims: 523x398x2mm
Code: PFW-A3-BL

Securit® Letter Shelf, including 169 double sided paper cards with letters, numbers and icons.
Dims: 25x250x2mm
Code: Sec-LES-TE-100



Securit® Stainless Steel Coffee Stencils - Face and Heart - set of 2. Dims: 100x124x1mm
Code: Sec-STN-SS-CO

Securit® Window chalkboard - Double sided writing surface - 4 suction cups included. Dims: 356x271x3mm
Code: Sec-PFW-27-36-BL



Securit® Stainless steel signage - (woman, man, woman | man, Arrow, No smoking and wheelchair friendly) - Set of 6
Dims: 100x100x2mm Code: Sec-SI-SS-SET



Securit® Liquid chalk marker stencil art set - Set of 6
Dims: 320x220x0.05mm
Code: Sec-SECSTN-5



Securit® Window Stencils, including chalk marker – Food & Drink Theme – Set of 3 x A2 Dims: 594x420x0.05mm
Code: Sec-WD-3A2-FD

Wooden Clipboard Menus & Menu Blocks

Premium Wooden clipboards are strong, good looking and make the perfect menu holder when sitting on a counter or table top. Simply slip your flyer under the fixed metal clip to start promoting. Dark Oak finish on 4mm Veneered MDF Boards. Fixed Metal Silver Clip. Designed to hold A4 or A5 menus/flyers. Add a Menu Base Block to enable the boards to stand.

- A4 Code: WC920G - D
- A5 Code: WC921G - D



Display your menus a bit differently using these elastic wooden menu boards. Available in A4 & A5 variants. Comes with 2 black elasticated bands (5mm) Use one or both bands to get the menu display that suits you, landscape or portrait possible from the same board. Another option to display multiple page menus by using just one band. Available in Natural Oak Finish with veneered 4mm board

- A4 size Code: WC894N
- A5 size Code: WC895N

Paddle Shaped wooden clipboards are strong, look good and make the perfect menu holder when sitting on a counter or table top. Can be self standing when used with a menu block base. Finish is natural oak with veneered finish and fixed metal clip. Made to hold A4 or A5 sheets with a 15mm surround border. Also comes with a 8mm diameter for hole wall mounting or hanging. Handle 130mm long. Available in two sizes A4 and A5 portrait.

- A4 size Code: WC916N
- A5 size Code: WC899N



Menu Base Block - Options



Hardwood menu holders with a slanted 4mm groove to allow our Clipboards or Unframed Chalkboards to stand on counters or tables. Works with items up to 4mm thick. Two Sizes available A4 or A5 long with Dark Oak stain. Height - 32mm, Depth - 75mm Groove is 5mm at a 5 degree angle (approx) Hardwood timber used to increase weight to hold securely the two sizes A4 & A5

- A4 (210mm W) Code: WC244D
- A5 (150mm W) Code: WC245D

Plain menu holder with a 3mm groove to allow menus to stand upright on tables and serve overs. Dimensions: 3mm thick, 20mm depth Dark oak stain 150mm (H) x 45mm (H) x 45mm (D) Pack size 10 units. Code: WC220



Wooden blocks that have a 3mm groove to allow menus and other displays to stand on a table top. Includes 3mm Groove Dark Oak Stain Perfect for table tops. Pack size 10 units Dimensions: 60 x 60 x 60mm, sold in single units. Code: WC209



On The Menu

Printed A4 Menu Chalk Boards

Double Sided Dark Oak Finish, Wooden Based Menu Board with Double Sided Chalkboard finish. Overall Height 310mm and overall width 210mm.

2 printed variants as follows: **Special Offer and Expert Butcher.**

Special Offer Code: WOD001Butcher

Expert Butcher Code: WOD001Expert



A4 & A5 Menu Chalk Board

Double Sided Dark Oak Finish, Wooden Based Menu Board with Double Sided Chalkboard finish. Overall Height 310mm and overall width 210mm with a chalkboard surface of 275mm high by 210mm in width. For use with Chalk Pens & Cleaning Solution or standard chalk.

A4 Code: WOD 001 A5 Code: WOD 006



A4 Table Top Chalkboard Menu Holder

Double Sided Dark Oak Finish, Wooden Based Menu Board with Double Sided Chalkboard finish. Overall Height 310mm and overall width 240mm with a chalkboard surface of 297mm high by 210mm in width. For use with Chalk Pens & Cleaning Solution or standard chalk. Code: WOD 004

A4 & A5 Chalk Board Easel

Single Sided Chalk Board Easel with Dark Oak stain, Easel base. Removable Blackboard allows easy writing/cleaning. Can be used for Chalk Boards or menu cards.

A4 Code: WOD 003

A5 Code: WOD 0051



Floor Standing A Frame Chalk Board

Double Sided Round Top Dark Oak Stained frame. Stainless steel hinges & stays. For use with stick chalk or chalk pens.

Size: A1 Code: WC150

Size: A2 Code: WC154

Floor Standing A Framed chalk Board

Double Sided Dark Oak Wooden A Frame Chalkboard, for use with Chalk Pens or Stick Chalk. Stainless Steel stays & Hinges.

A1 Code: WC151

A2 Code: WC155



Dark oak framed chalkboards

are made with a mitred, solid wooden 40mm frame with a shiny chalkboard finish to allow chalk pens to be wiped off easily. Use with Chalk Pens & Cleaning Solution.

Size: A1 625x870mm Code: WC311

Size: A2 430x630mm Code: WC312

Size: A3 325x450mm Code: WC313



Hooks *With Pricing Arms*

Rear Support Bar (RSB)

Rear Support Bar suitable for main floor Dry Grocery Shelving Systems.
For use with RSB Hooks.

Width Size:

665 mm (7 mm Solid)

1000 mm (7 mm Solid)

1250 mm (7 mm Solid)

Code:

RSB BAR 665

RSB BAR 1000

RSB BAR 1250



Rear Support Bar (RSB) Hooks

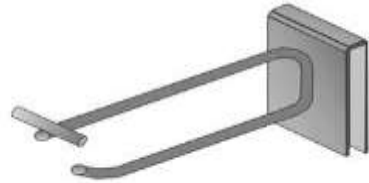

Single Rear Support Bar hook with pricing arm 6 or 8 mm wire thickness lengths as below, back plate to suit 7 mm RSB Bar

Size:

200mm (6 mm wire)

300mm (8 mm wire)

Code:

RSBS - 200

RSBS - 300

Double Rear Support Bar hook with pricing arm 5 mm wire thickness lengths as below, back plate to suit 7 mm RSB Bar

Size:

200mm (5 mm wire)

300mm (5 mm wire)

Code:

RSBD - 200

RSBD - 300

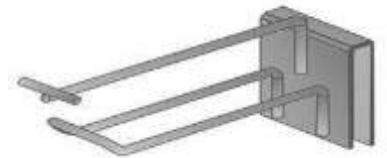

Slat Wall Hooks

Single Slat Wall hook with pricing arm 6 mm wire thickness lengths as below, back plate to suit Slat Wall

Size:

150 mm (6 mm wire)

200 mm (6 mm wire)

250 mm (6 mm wire)

Code:

SLATS – 150

SLATS – 200

SLATS – 250

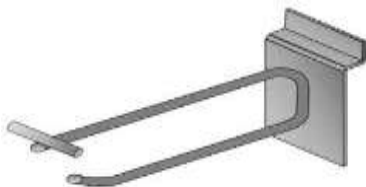

Double Slat Wall hook with pricing arm 5 mm wire thickness lengths as below, back plate to suit Slat Wall

Size:

150 mm (5 mm wire)

200 mm (5 mm wire)

300 mm (5 mm wire)

Code:

SLATD – 150

SLATD – 200

SLATD – 300

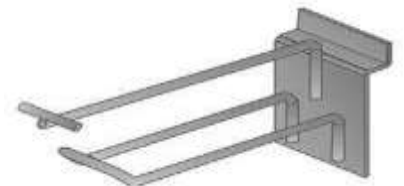

Price Tags & Accessories

Price Tag for Hooks with a pricing arm
Size: 39mm x 62mm ticket holder clear or white
Code: WMVP

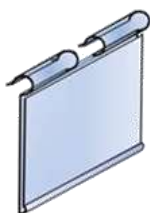

Price Tag for Double Peg hook
Size: 27mm x 32mm ticket holder
Code: 1000-5



Hang Tabs – self adhesive with 1,000 pcs per roll, for use with Double Peg hooks
Size: 50x50mm
Code: ERT-04



HACCP Station

Universal Wall Mounted HACCP Station.
Material Acrylic, with 4 landscape tiered shelf slots. Code: HACCP

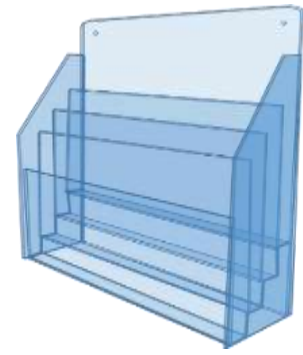

ACRYLIC Menu Holders with Stainless Steel Base

Securit® Removable double-sided acrylic table display with stainless steel base -A4, A5 & A6

A4 Dims:332x207x75 Code: SEC-PFT-ACM-A4

A5 Dims:243x150x74 Code: SEC-PFT-ACM-A5

A6 Dims:165x105x74 Code: SEC-PFT-ACM-A6



Petrol Pump Toppers



Self Standing A4 Landscape Petrol Pump POS Holder, Material PETG with Foam PVC Base including Tape for Fixing. Holds a double sided print in a landscape format. Size: A4 Code: PET23

ACRYLIC Menu Holders

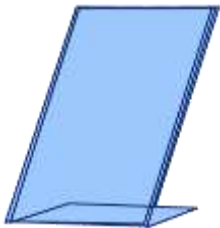

Self Standing Portrait Angled Menu Holder, Material 2mm Acrylic.
Size: A4 Code: ACR 14
Size: A5 Code: ACR 18



Portrait Angled Menu Holder With Sucker Pads on base. Material Acrylic. Size: A4 Code: ACR 15



Portrait double sided menu holder. Self standing. Material 2mm Acrylic.
Size: A4 Code: ACR4
Size: A5 Code: ACR2
Size: A6 Code: ACR021

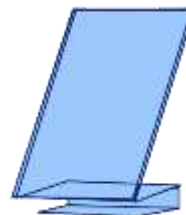

Portrait Angled Menu Holder With Clamp function on base. Material PETG
Size: A4 Code: ACR 13



Portrait (P) or Landscape (LS) wall mounted menu holder. Material Acrylic. Self adhesive pads on one side to fix to a wall type surface.
Size: A4 Portrait Code: ACR23
Size: A4 L/Scap Code: ACR26



Y Shaped Table Top Menu Securit® 6 sided Acrylic Transparent poster holder - Y-Shaped. A6 Dims: 150x95x95mm
Code:Sec-PFT-ACY-A6

Poster Holders

Portrait Menu Holder With 90 degree bend for mounting under product or boxes for displaying Offers, or other information on pallet or stack displays. Material PVC.

Size: A4

Code: PVC 05

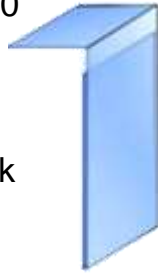

Portrait wall mounted PVC menu holder, with self adhesive tape on one side to fix to a flat type surface.

Size:

A3

A4

A5

Code:

PVC 26

PVC 10

PVC 41

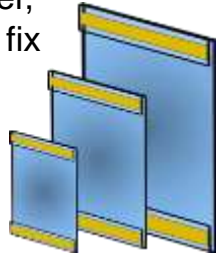

PVC WINDOW POSTER HOLDER WITH SUCTION CUPS on top for mounting onto glass for displaying posters either double or single sided messages. Material 0.4mm PVC . Can also be supplied with out the suction cups as shown to the below right.

Size:

A4

A3

A2

A1

20" by 30"



Code:

PVC 15

PVC 25

PVC 16

PVC 17

PVC 18

Size:

A4

A3

A2

A1

20" x 30"



Code:

PVC 33

PVC 32

PVC 31

PVC 30

PVC 34

POSTERfix

**DISPLAY,
THE EASY WAY**

Ideas & Inspiration

The easy to fit reusable Poster System & removable leaving no residue on glass.



- Easy Fitting or repositioning
- Removable, leaving no residue
- Easy to change poster
- Double sided display on glass
- Brand-able header and footer
- Wide range of solutions & uses, including Offers, Menus, Opening Hours or Safety Notices.



Code, Size & Colour

Posterfix Portrait Red A4

Posterfix Portrait Grey A4

Posterfix Portrait Grey A3

Posterfix Portrait Grey A2

Posterfix Portrait Grey A1



Window Cable Display

Window Cable display set consisting of the following:

2 by 4m wire with top and bottom fixings, 4 by Cable Clips Large 6mm or 4 by Cable Clips Small 2mm and one by acrylic wallet with cover clip.

Size: A3 297 x 420mm

Code: CSET A3

Size: A2 420 x 594mm

Code: CSET A2

Size: A1 594 x 841mm

Code: CSET A1

Fitting costs available on request.

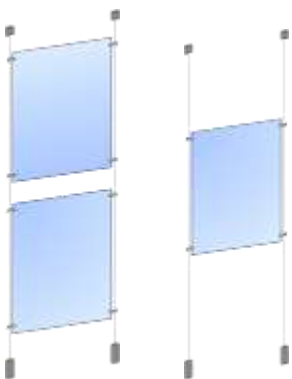

Frame & Accessory Sets

A4 Self standing pole, frame, insert and plastic base.
 Black Pole height 300mm extends to 600mm.
 A4 Frame Clear or Black Code: SET 01

Pole Colour
 Options of
 Black, or
 Silver



A3 Self standing pole, frame, insert and plastic base.
 Size: Pole 300 mm extends to 600 mm
 A3 Frame Clear or Black Code: SET 05

Frame, Insert & Magnet Base



Frame, insert and magnet base White or Black Magnet.
 Size; A4 Frame Clear or Black
 Black magnet set Code: SET 03
 White magnet set Code: SET 04

A4 Wine Topper, Frame & Insert

Bottleneck Holder for off licence, goes over the top of screw top bottles and has a frame adaptor included. Inclusive of A4 Frame and Insert.
 Colours – Black or Clear. Code: SET 08



Suspension Frame Sets

Frame, insert & skyline track for hanging frames. 2m silver anodised profile complete with hanging wires, ceiling clips and 4 x A4 frames with inserts.

2m Set: Code: 2 MTR SUSPENSION
 Connector Code: 9178369



Freezer Rail Sets



Frame, insert & Freezer Track. The Track is a PVC profile 1250mm long, with a foam adhesive base for easy fitting. The placement of the track is shown in pictures to the right. The set comes complete with three A4 frames with inserts and three frame clips which can be clipped on at any point along the track.
 1250mm Set: Code: SET 07



Wire Display Bin Sets



Wire Display Basket ALSO includes Spring Mounted Pole with Black or Clear A4 Frame & Insert. Polished zinc finish. Product has a collapsible base which can be moved upwards as the product is selling out. Ideal for mid floor, end of aisle or side displays.
 Standard Size 420 Square x 770 High
 Code: DUMP BIN SET C

Frames & Accessories

Extendable Pole & Base

Size:	Code:
Black pole 1100 to 1400	8312626
Black pole 350 to 550	8312619
Silver Pole 300 to 600	8312621
Plastic Base	8312659
Metal Base	8312631
90 Degree Magnet for Frames, Black	8371059
90 Degree Magnet for Frames, White	8312575



Metal

Plastic

Magnet



Frame & Insert options for above clamp.

Size:

A4 Clear Frame Code: 8312594	-	A4 Black Frame Code: 8312548
A3 Clear Frame Code: 8312571	-	A3 Black Frame Code: 8312538
A4 Insert Code: 8312644		
A3 Insert Code: 8312643		

Fruit & Veg Black Box Clamp, use with standard frames, for use in Heavy Duty Areas, such as Fruit & Veg, Wood Crate or Box Displays. Frame & Insert not included Code: 9173217



Clear Clamp for use with standard frames for glass edges such as Spider Fridges or open cheese displays. Frame & Insert not included Code: 9173219



Telescopic Poles with "T" piece and Spring Holder for mounting poles on wire baskets. Size available extends to 420mm. Frame & Insert not included. Colour: Dark grey powder coated.

Code: 8312637

Display Bin Poster Surrounds

DUMP BIN TALKER. A2 PVC Poster wallet. Wallet is fixed on the top of the dump bin as shown and holds an A2 paper quality poster. Can be used to the front of a single bin or where there are a number of bins together to create a surround as shown on left.

For Use With 420 square wire display bin.

- Code: PVC 16db
- Code: A2 P SOwhitered
- Code: A2 P SOwhitegreen

If you require other A2 Posters than the above listed, please contact our office for further details on 01 - 4587470



Tego Style
Shelving

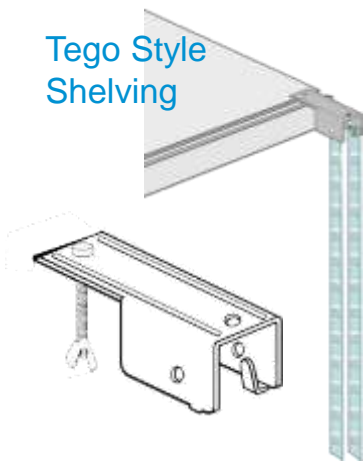

Shelf Edge Merchandising Hook

Use on gondola runs at shelf edge to maximise selling space. Promote impulse purchasing while creating "Secondary Sightings" the unit holds two Hang Strips on self contained hooks as shown. Metal construction with black powder coated finish. Suitable for Tego or Eden shelving as the units are fixed with a screw & wingnut through holes in the front "U" channel on either side of the shelf.

Code: MET 03

Merchandising Hang Strips

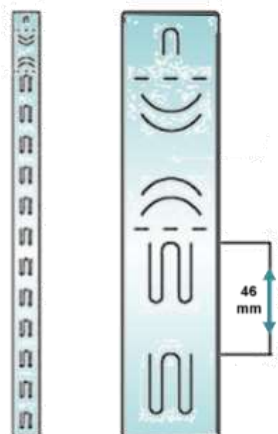

For use on shelf edge or for hanging products on the edge of displays. The main purpose is for secondary sighting of products, which in turn promotes impulse purchases. Strip is only suitable for light weight products. There are 12 hooks to a strip, in a length of 646mm and the colour of the strip is transparent.

Code: 007



White Plastic Hook for hanging above Merchandising Hang Strip on displays or shelf edge. Code: 601-254



Metal Clip strip - With hanging hook .. colour zinc finish
There are 12 hooks to a strip, in a length of 700mm.
The header panel is 32x80mm.

Code: MET300



Hang Tabs – self adhesive with 1,000 pcs per roll, for use with Double Peg hooks Size: 50x50mm

Code: ERT-04

Food Information Regulations (FIR)

Wall Fixed Binder Holder
A4 Binder Brochure
holder with fixings
Code:
EX-A4binder WML



Freestanding Centre Floor
1.4m high pole with A4 snap frame and
metal shelf to take A4 Binder
Code: SBS Binder Set
Internal dimensions of metal shelf
268mm wide x 58mm deep



Brochure Stands



Single Sided Pole with A4 Frame and
Shelf 1400mm Aluminium Pole & base,
1 by A4 Snap Frame, 25mm Profile and
1 by silver metal A4 brochure shelf.
Code: SBS – SET 1



Double Sided Pole with A4 Frame and Shelf
on each side.
1400mm Aluminium Pole & base, 2 by A4
Snap Frame, 25mm Profile and 2 silver
metal A4 brochure shelves. Code: DBS –
SET 1



Single Sided Pole with 2 by A4 Frame
and Shelf
1400mm Aluminium Pole & base, 2 by
A4 Snap Frame, 25mm Profile and 1
by silver metal A4 brochure shelf
Code: SBS – SET 2



Double Sided Pole with A4 Frame and
Leaflet Box on each side.
1400mm Aluminium Pole & base with 2
by A4 Snap Frame, 25mm Profile and 2
by Polycarbonate A4 Brochure holders.
Code: DBS – SET 3



Single Sided Pole with A3 Landscape
Frame and A4 Leaflet Box. 1400mm
Aluminium Pole & base, 1 by A3 Snap
Frame (25mm Profile) and 1 by
Polycarbonate A4 brochure holder.
Code: SBS – SET 4



Double Sided Pole with A3 Landscape
Frame and A4 Leaflet Box on each side.
1400mm Aluminium Pole & base, 2 by
A3 Snap Frame (25mm Profile) and 2 by
Polycarbonate Brochures Holders.
Code: DBS – SET 4

Self Standing Brochure Holders



Description: A4 Self Standing
Leaflet Box
Code: EX - 1A



Description: A5 Self Standing
Leaflet Box
Code: EX - 2



Description: 1/3 A4 Self Standing
Leaflet Box
Code:
EX - 3

Wall Mounted Brochure Holders

A4 Wall Mounted Leaflet Box
Code: EX - 10



A5 Wall Mounted Leaflet Box
Code: EX - 11



1/3 A4 Wall Mounted Leaflet Box
Code: EX - 12



Elevating...Key Categories

Lift & Drop signage

Help customers navigate your store or Highlight Key Categories.

The Modular Signage Solution that can be quickly & easily updated.

Lift & Drop signage is a flexible and adjustable store communication solution that's user-friendly for store staff. In a matter of seconds, Lift & Drop signage can be easily updated, making panel changes quick and easy.

Key benefits

- Help shoppers navigate the store
- Enable store branding
- Enhance the shopping experience



For More Information Contact Our Office or send your query to salesireland@hl-display.com

Category Signage Arms & Brackets



Magnetic Arm Aisle Sign Holder for under shelf on metal shelves. Recommended for use in refrigeration rather than main floor ambient shelving. Base is adjustable for use where shelves are angled & the arm has 2 hooks for holding pre punched signage
Code: MAG-ARM

Extendable sign holder for connecting to your upright and displaying category or aisle signage. Recommended for use main floor ambient shelving. The arm has 2 hooks for holding pre punched signage . The arm extends from 605mm to 750mm.
Code: 819520

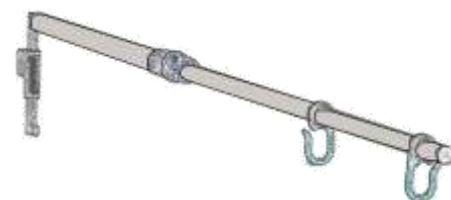

G Clamp can take print of 5 to 6mm thick (recommended material Foam Board). The sign holder is hinged, so the Aisle Fin will re-centre when moved. Code: MET 01

Under Shelf Bracket Clamp. Takes print of 5 thick . The sign holder is hinged, so the Aisle Fin will re-centre when moved. Bracket attaches to the underside of the shelf bracket. Adjustable front bracket for use on angled shelves.
Code: METAL CAT CLAMP



Signage – Snap Frames & Pavement Signs



Banner Snap - Headboard Holders. Consists of Top Bar with two eyelets for hanging & Bottom Bar for base of sign. Both aluminium bars snap closed to grip sign. Included in set are two ceiling clips and spring hanging wires. Code: 00.235 - PH

Snap Frames - Wall mounted 25mm edge profile Snap Frame from A1 to A4 size & 32mm edge profile Snap Frame in AO size. Silver anodised finish with mitred corners.

Size: AO	Code: 05.AO Snap Frame
A1	05.111-WR
A2	05.112-WR
A3	05.113-WR
A4	05.114-WR

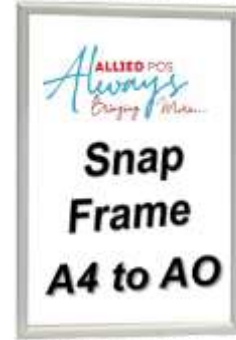

Wind Talker, with a moulded plastic base – recommended to fill with sand to give extra weight to the stand in order to be more wind resistant. Rounded corners and also has wheels on one side to enable stand to be wheeled to location. Poster on both sides, A1 Size is available in Black or Silver Anodised Finish & AO is only available in Silver Anodised finish.

Cost: A1	Code: WTA1
Cost: AO	Code: WTAO



A frame A1, brushed aluminium finish, rounded corners takes poster on both sides. Recommended for indoor use only. Size A1, other sizes available on request only. Code: 15.100

Replacement Covers for Snap Frame Signage Holders. Material is anti reflective and is available in the below sizes.

Size:	
AO	841mm x 1189mm
A1	594mm x 841mm
A2	420mm x 594mm
A3	297mm x 420mm



Code:	
RC AO	
RC A1	
RC A2	
RC A3	



Signage Black Board Inserts PVC Marker Black Board insert for wall mounted snap frames or standard frames. Other sizes available on request. For use with chalk Marker Pens.

Size:	Code:
A1	8311971
A2	8311972
A3	8311973
A4(5 Pack)	8311974



Basket Trolley



Two Basket Trolley. Encourages extra impulse sales for basket shoppers.
Available with Red or Black handle.
Red Code: T6 RED Black Code: T6 BLACK



Plastic Shopping Baskets







38L Wheeled Basket with extendable handle. Encourages impulse sales for basket shoppers. Available in Red, Black, Green or Blue, for other colours please contact our office on 01 4587470
Red Code: 38L RED Black Code: 38L BLACK Green Code: 38L GREEN



28ltr Plastic Basket with two black handles. Various colours available including Red, Green, Blue & Black.
Code: 28LPLBasket – Colour

22ltr Plastic Basket with single black handle. Various colours available including Red, Green, Blue & Black.
Code: 22LPLBasket – Colour



Baskets Standard Colours	
	Black
	Blue
	Green
	Red

Eco Friendly Rolling Basket.....



Sustainable Choice 38L Wheeled Basket with extendable handle. Encourages impulse sales for basket shoppers. Colour Black.
Code: ECO 38L



100% Recycled 28ltr Plastic Basket with two black handles. Colour Black. Code: ECO 28L



100% Recycled 22ltr Plastic Basket with single black handles. Colour Black. Code: ECO 22L



Wire Shopping Baskets



19ltr Wire Basket with polished zinc finish. Various handle colours available including Red, Green, Black. Quantity 20 per box. Code: 19L - Colour



Mobile Basket Stacker, Available in polished zinc finish to suit plastic and wire basket sizes.
Code: Basket Stacker No Handle



Hi-Back Basket Stacker Mobile. Polished zinc finish to suit the Wire baskets, with 75mm wheels and suitable for 19L and 25L baskets. Code: Hibackstacker

Hand Label Solutions & Accessories



1-line hand labeller with 5-10 printing digits 5 and 5,7 mm height, suitable for 22 x 12 mm and 26 x 12 mm wavy edge labels.

Code: EXPERT-S-1

Price Labels

26x12 Price labels are suitable for all Meto & Tovel Pricing Guns

White Permanent Code: 9193883

White Removable Code: 9199600



26x12 mm

26x16 Price labels are suitable for all Tovel and Meto Pricing Guns. Plain White Code: 9197072



26x16 mm

Ink Roll Replacements

Ink Roll Replacements EXPERT-S-1

5 ink rolls p. Blister pack suitable for EXPERT-S-1.

Colour: Black Code: 9321597

Ink Roll Replacements TOVEL Entry ONLY

5 ink rolls p. Blister pack suitable Tovel Entry Pricing Gun.

Colour: Black Code: 9294071



Kick Stools

Metal Kick Stool – with collapsible wheels for stability when in use. Height 430mm, Top Diameter 300mm, Bottom Diameter 450mm. Colour: Grey

Code: KICKSTOOL



Bag Holders

Stand Alone Fruit & Veg Bag Holder – Used for holding bag rolls in the Fruit & Veg area . C/W lid & tear pin. Code: BAG HOLDER STAND

Fruit & Veg Bag Holder – Used for holding bag rolls in the Fruit & Veg area on angled displays Code: BAG HOLDER



Stock Trolley

STOCK TROLLEY - Height 1190 mm - Width 500 mm

- Length 1240 mm C/W 2 directional wheels & 2 set wheels Code: STOCKTROLLEY



Flower Stand - Mobile 6 buckets

Transportable metal framed flower display stand with lockable castors. Suitable for indoor and outdoor use. Folds flat for storage. Include 6 plastic buckets. Code: 172101



In Queue Merchandising

Maximise your selling opportunities, while managing customer flow at your checkouts.



Key benefits

- Drives sales – promoting impulse purchase at tills while managing customer queues.
- Double sided systems can be shopped from both sides
- Increased Selling space while using corner units.
- Durable & Compatible with standard shelving systems

Extra

selling space
on corners with the 3 shelf
set, NQ MET CNR3

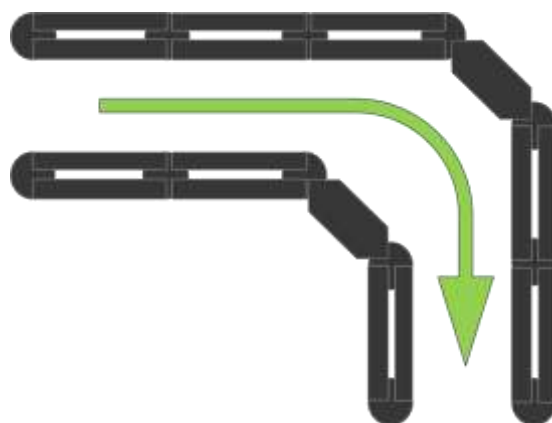

Contact our office for details or with your enquiry



In Queue

Piece Parts



Metal base and welded upright. 5MM thick with 300D base with welded 30 x 30 upright with a height of 1010mm.
Code:NQ SUP



Corner shelf set of three. Used to create a 90 degree soft turn on the queue system while creating extra selling space on the corners. Base & uprights are ordered separately. Dims: 525W x 280D. Code:NQ MET CNR3

A4 metal screw in frame for directional signage.
Code:NQ A4



Mesh metal shelf, Ideal for Adult Snacks, Confectionary or other impulse items. Dims 1000W x 200D with a front height of 80H and back height of 200mm. Code:NQ MESH SHELF



Solid metal shelf, Ideal for Adult Snacks, Confectionary or other impulse items. Dims 1000W x 200D with a front height of 70H and back height of 130mm.
Code: NQ METT SH 1000/200



Mesh Metal shelf which fixes to the top of each upright. Ideal for Chewing Gum, Confectionary or other impulse items. Dims 420W x 270D x 80H. Code:NQ Top Shelf

Rear Support Bar. When using bars both sides bay widths can correspond to the required size needed. For example 665mm, 1000mm or 1250mm wide bays. For use with RSB Hooks.

Width Size:

665 mm (7 mm Solid)

1000 mm (7 mm Solid)

1250 mm (7 mm Solid)

Code:

RSB BAR 665

RSB BAR 1000

RSB BAR 1250

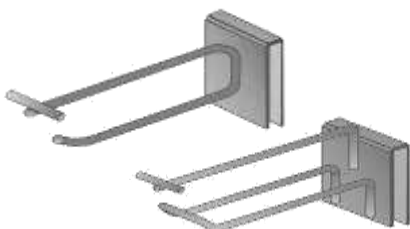

Single & Double Rear Support Bar hook with pricing arm length as below, back plate to suit 7 mm RSB Bar

Size:

Single 200mm (6 mm wire)

Double 200mm (5 mm wire)

Code:

RSBS – 200

RSBD - 200

Price Tag for Hooks with a pricing arm. Size: 39mm x 62mm ticket holder clear or white

Code: WMVP



Fresh Off The Press - Magazine Display Racks

New Look & Feel For Today's Stores...



Standard Volume 65mm deep racks to suit 1M bays, compatible with our Q system or standard 1M bay widths.



Wire Mesh Black 1 Tier
Code: WM-1T-1M
Bay Width: 1000mm

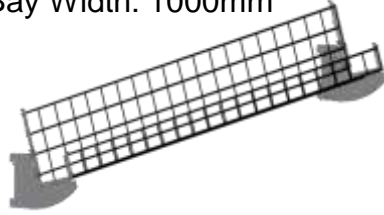

Acrylic 1 Tier
Code: ACRMAG-1T-1M
Bay Width: 1000mm



Wire Mesh Black 2 Tier
Code: WM-2T-1M
Bay Width: 1000mm

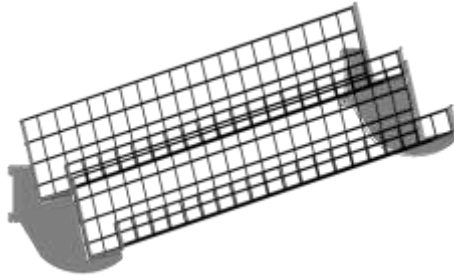

Acrylic 2 Tier
Code: ACRMAG-2T-1M
Bay Width: 1000mm

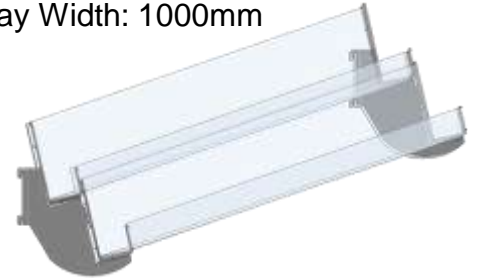

Wire Mesh Black 3 Tier
Code: WM-3T-1M
Bay Width: 1000mm

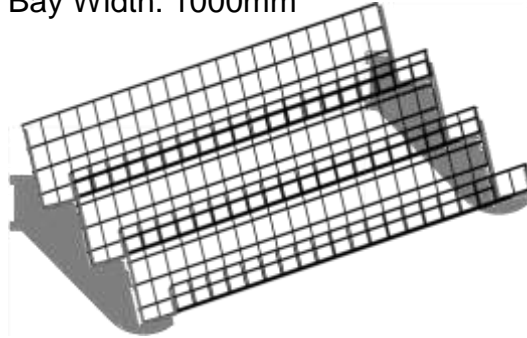

Acrylic 3 Tier
Code: ACRMAG-3T-1M
Bay Width: 1000mm

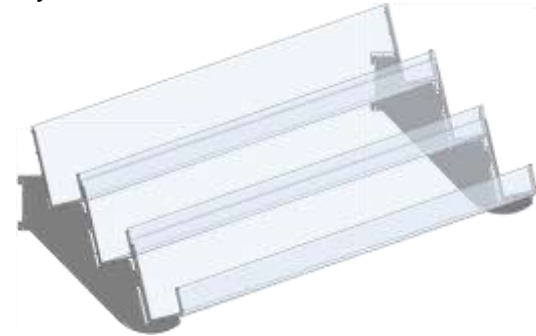

Newspaper Display Stands & Rack

Newspaper Display Stands. Options include 12 titles, 8 Titles & 4 Titles. Stands are of Metal Construction with powder coated finish and comes with 4 castors & locking options for wheels.

Available in Black or Grey Powder Coated Finish.



12 Title Code: Newstree Silver or Black
Dims: 640mm Wide X
810mm Deep X 1310mm High

8 Title Code:
News Tower Double Silver or Black
Dims: 660mm Wide X
460mm Deep X 1310mm High

4 Title Code:
News Tower Single Silver or Black
Dims: 410mm Wide X
460mm Deep X 1310mm High



Ceiling Hanging Wires & Clips

Solid ceiling hook for suspending POS signs.

Size:	Code:
65mm S Hook	1617
200mm	8350 336
300mm	8350 330
500mm	8350 331
700mm	8350 332

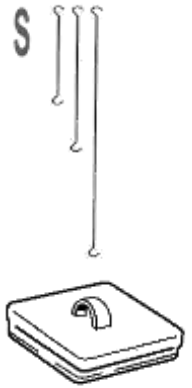

Sign ceiling grid clip.
Code: 7103



Stick on ceiling clip.
Code: 2279

Sign Wire ceiling grid clip.
Code: 8311104



Clamp on ceiling grid clip
Code: 9217859



Budget Q Control System



Securit® Budget retractable barrier set (pole & base) - Black nylon tape (2100mm) - Set of 2. Poles are available in Black or Chrome finish.

Dims:	930 x 330 x 330 mm 7,9kg
Chrome Finish Code:	Sec-RS-RT-LW-CH
Black Finish Code:	SEC-RS-RT-LW-BL



Standard Q Control System



Securit® retractable barrier set for wall mounting - Red nylon tape (2100mm) - Set of 2

Dims:	143 x 75 x 50 mm 0.4kg
Code:	Sec-RS-RTWM-RVS-RD



Securit® retractable barrier set for wall mounting - Grey nylon tape (2100mm) - Set of 2

Dims:	143 x 75 x 50 mm 0.4kg
Code:	Sec-RS-RTWM-RVS-GY



Securit® Retractable barrier poster frame - stainless steel or black finish - screws to top of post.

Size A4	Dims: 453 x 218 x 67mm
Code:	Sec-RS-SIGN-A4-PS
Code:	Sec-RS-SIGN-A4-BL



Securit® retractable barrier set (pole & base) – Grey nylon tape (2100mm) –

Dims:	1010 x 510 x 330 mm 7,9kg
Code:	Sec-RS-RT-RVS-GY- SET





ALLIED POS
Always Bringing More...

Central Billing Supplier Point Of Sale Catalogue

Unit 10 Block 14G, Beechwood Buildings, Greenogue Business Park, Rathcoole, Dublin 24.

Phone: 00353 (0)1 4587470 Fax: 00353 (0)1 4587472

E Mail: salesireland@hl-display.com

Web: www.hl-display.com & www.alliedpointofsale.ie

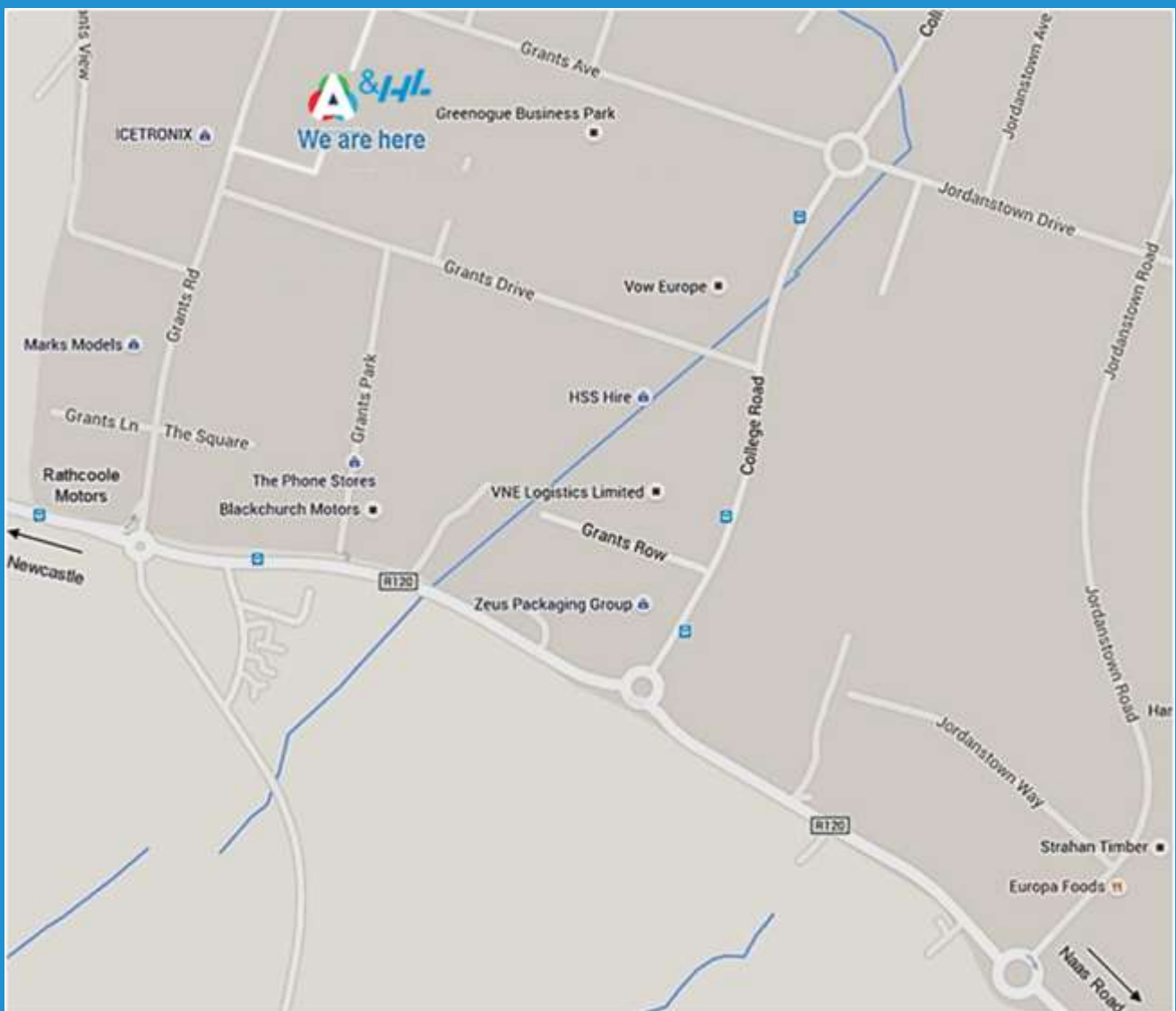

**Ownership of any goods remain the property of HL & Allied Point of Sale Ltd until all monies due are paid in full. All products are subject to availability.
Updated catalogue Coming Soon.....**