



**ALLIED POS**  
*Always Bringing More...*

*Inspiring  
Ideas*



**2021**

**Visit Our Showroom. Just 5 mins off the N7.**

[www.alliedpointofsale.ie](http://www.alliedpointofsale.ie)

# Sustainable Poly Display Crates

To use on side stacks or on shelf as part of a display.

The new generation RPC brings a softer look, while meeting sustainable criteria.....

- Replace traditional wood crates with our new RPC's for a sustainable and hygienic solution
- Robust product protection during transportation
- Foldable and stackable to maximize space
- Active Lock system.
- Extra light weight for handling without the splinters or wires
- Environmentally friendly, fully recyclable
- Easy to clean polymer – resists moisture, insects and fungi; impervious to acids, fats, solvents and odours

Code: 6416 Standard

Size : 600 x 400 x 163mm

Code: 4316 Half

Size : 400 x 300 x 163mm



## Smart Edge Crate Cover Baskets – The First Step In Adapting to the latest trends in produce presentation.

Available in Black Poly-Wicker & Brown Wicker Basket edge finishing.

- Create A More Premium Display.
- Highlight Sections, Organic Produce or Premium Ranges.
- Hygienic & Easy To Handle.
- Choice Of Finish, Black Food Safe Poly-Wicker for Crisp Product Popping Displays or Brown Wicker To Give A Powerful Ecological Appearance.

Ideal for creating a more premium display, while keeping in line with food safety standards. Designed to slip over standard fruit and veg Size 600 x 400 x 160mm H

Ideal for creating a more premium display, while keeping in line with food safety standards. Designed to slip over standard fruit and veg

Size: 600 x 400 x 160mm H

Black Poly-Wicker

Code: BAS-AI BLACK

Brown Wicker

Code: BAS-AI RATTAN



Black Poly-Wicker  
Artificial  
Material



Brown  
Wicker  
Artisanal  
Material

Looking For More Choice Visit Our Website : [www.alliedpointofsale.ie](http://www.alliedpointofsale.ie)



# Contents

Page 2	Simple Click Systems – Cool System – Designed For Chilled Presentation
Page 3	Simple Click Systems – Cool System – By The Shelf Ready Reckoner
Page 4	Simple Click Systems – Cool System – Piece Part
Page 5	Other Shelf Management – Chilled Produce
Page 6	Simple Click Systems – Shelf Management– Med & Vitamin / Personal Care
Page 7	Simple Click Systems – Shelf Management – Ready Reckoner Med & Vitamin
Page 8	Simple Click Systems – Shelf Management – Ready Reckoner Personal Care
Page 9	Simple Click Systems – Shelf Management – Nuts & Seeds Packs
Page 10–11	New Format Shelf Talkers – Bakery Treat & Standard Shelf Talkers
Page 12–13	Shelf Fronts – Data Strips – Risers & Biscuit Stops
Page 14–15	Feature Display – Carts & Tables
Page 16–17	The Vintage Artisan Look – Feature Floor Displays & Props
Page 18	Hessian Sacks & Rolls – The Vintage Look Serious About Theatre
Page 19	Imitation Cheese – Prop Up Your Charcuterie
Page 20	Imitation Food Props – F&V, Continental Meats & Garlands
Page 21	Imitation Food Props – Fish Counter Props
Page 22	Artisan Poly-Wicker Feature Display Stands & Baskets
Page 23	Artisan Poly-Wicker Display Baskets
Page 24–25	Multi Functional Counter Display Stands, Props & Accessories
Page 26–27	Presentational Food Safe Display Platters – Melamine & Wood Effect Melamine
Page 28	Polaris Food Safe Melamine Display
Page 29	Deli POS & Props – Slate Display & Tasting Stands
Page 30–31	Vintage Look Wine Display – Crates, Barrels, Props & POS
Page 32–33	Coloured Wood Crates – Shelved Crates – Crate Bundles
Page 34–35	Chalk Board Menu Holders – & Chalk Board Signage
Page 36–37	Chalk Board – Table Top & Silhouette Shaped
Page 38	Something Different – Signage & Display Signage
Page 39	Wood Clip Board & Menu Block Solutions
Page 40–41	Table Top Menu & Stands – Wooden Chalk Board – Framed & Unframed
Page 42/43/44	Serve Over Pricing Solutions – Hot Tickets, Ticket Stands & Clips
Page 45	Deli PVC Tickets – Chalk Pens & Accessories
Page 46	HACCP Station – Menu Holders – Acrylic & Acrylic with Plywood Base
Page 47	Pizza Display – Pump Toppers – Poster & Signage Holders – PVC
Page 48	Window Signage – Category Signage Holders & Solutions
Page 49	Pavement Signage & Snap Frames
Page 50–51	Frames & Accessories – Sets / Frames & Accessories – Parts
Page 52	Branded Special Offer Display Bins – Shelf Edge Merchandising Strips
Page 53	Brochure Stands & Counter Top/Wall Mounted Brochure Holders
Page 54–55	Shopping Baskets, Kick Stools, Bag Holders & Miscellaneous Items
Page 56–57	Magazine Racks – Newspaper Stands & Racks
Page 58	Queue Barriers & Ceiling Signage Accessories
Page 59	Queue System with Merchandising Options – Accessories & Parts
Page 60	Merchandising Hooks with Pricing Arm & Ticket Holders
Page 61	End Display Highlighting & Pricing Guns / Labels



## Why SimpleClick Fresh?

- Better Presentation Promotes Impulse Sales.
- Reduce Costs, Less Labour Intensive.
- Improve Stock Rotation & Reduce Waste
- Front Facing, Better Shop-Ability for Customers
- Better Visibility of Range.
- Allows shopper to find product easily.
- Instant Identification of off sales.
- Improve Category & Store Image.

### Fresh Pre-Pack...

Push Feed. Pre Packed Cooked Meats, Breakfast Meats, Cheese & Ready Meals.



### Fresh Pre-Pack Bagged Salads & Vegetables ....

Large Magnetic Support. Bagged Salads & Bagged Prepared Vegetables.

# Maximum Possibilities with minimum parts

Prepack Produce Average Facings Per Shelf	Parts Needed For Average Shelf within a Full Bay	Assembly Code
Cooked Meats Pre Pack Av 7 Facings	Magnetic Front x 1 – Divider x 8 – Pusher x 6	CPMeat PP
Cheese Pre Pack Av 8 Facings	Magnetic Front x 1 – Divider x 9 – Pusher x 6	CPCheese PP
Breakfast Meats Av 6 Facings	Magnetic Front x 1 – Divider x 7 – Pusher x 4 – Ladder & Support x 2	CPBreakfastPP
Ready Meals Av 6 Facings	Magnetic Front x 1 – Divider x 7 – Pusher x 3 – Ladder & Support x 2	CPRMealsPP
Pre Packed Fish Average 7 Facings	Magnetic Front x 1 – Divider x 8 – Pusher x 5	CPFishPP
Prepack Salad/Veg Average Facings Per Shelf	Parts Needed For Average Shelf within a Full Bay	Assembly Code
Bagged Salads Av 5 Facings	Magnetic Front x 1 – Divider x 6 – Large Magnetic Support x 5	CP PPSALAD
Prepacked Veg Av 6 Facings	Magnetic Front x 1 – Divider x 7 – Large Magnetic Support x 6	CP PPVEG
Front Of Store Fridge - Average Facings Per Shelf	Parts Needed For Average Shelf within a Full Bay	Assembly Code
Front Of Store Fridge 1335mm width	Magnetic Front 667mm x 2 – Divider x 11 – 14N Pushers x 6	CP CT FOS Fridge
Front Of Store Fridge 1m width	Magnetic Front 985mm x 1 – Divider x 10 – 14N Pushers x 5	CP CT FOS Fridge 1M
Divide Only Chilled Average Facings Per Shelf	Parts Needed For Average Shelf within a Full Bay	Assembly Code
Sandwich / Wraps / Fruit Bowls	Magnetic Front x 1 – Divider x 6	CP SWFB
Yogurts Divide Only	Magnetic Front x 1 – Divider x 6	CP YOGURTS
Prepack Raw Meats Divide Only	Magnetic Front x 1 – Divider x 4	CP RAW MEATS



**Striking  
Presentation  
Generates  
Sales.....**

**Make Your  
Range More  
Visible To Your  
Customer.....**

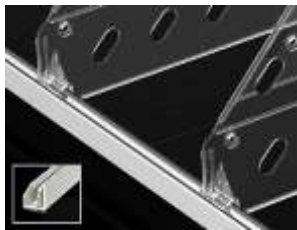

**Fresh Front Rail Magnet**, silver, length 1250mm. Use together with the Cool snap-off dividers, and /or Cool Product Pusher / Cool Ribbed Base and Standard Support or Large Support.  
Code: CP PA-1003

**Fresh Breakable Divider** 140mm high & breakable from 485 to 285 deep. Use together with the Cool Front Rail. Due to the specially developed nose of the Cool snap-off divider, rear attachment is not necessary.  
Code: CP PA-1008

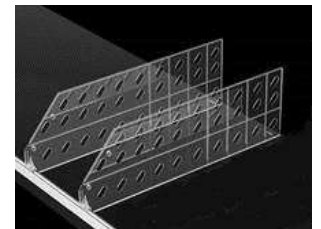

**Fresh Product Pusher**. The telescopic rail is adjustable and fits shelves from 330mm to 600mm. The pusher can be mounted both upright and at an angle for product display purposes. Suitable for Meat, Cheese, Ready Meals & Fish for product weights from 150gr to 250gr  
Code: CP ZLH 1401

**Fresh Presentation Standard back support** For use when products are difficult to push, such as cling film type packs. A spring loaded pusher can still be used to provide support if wanted, but may not be as effective. Size 80mm W by 140mm H  
Code: CP PA-1009 + CP PA-1010

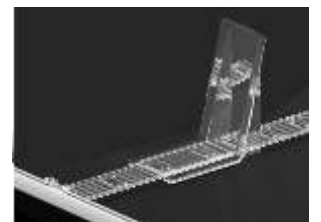

**Fresh Large back support Magnetic** For use when products are large, heavy or bagged, such as cellophane packs, such as Bagged Salad or Prepped Veg. Size 120mm W by 185mm H  
Code: CP PD 6014Magnetic



# Shelf Management

## Pizza Display Steps



Angled Step for display of Fresh Pizza. For use in Mid floor chilled units (Spider Units). The step is 300mm by 290mm in size and has routed slots on the base for airflow. The typical spider unit uses 9 steps per unit. Material - PETG 4MM Size - 300mm by 290mm  
Code: PET04



6 Facings deep upright pizza display. Material 5.0mm PTEG. Dims:150mmW x 435mmD x 135mmH  
Code: PET-54



## Standard Manual System

### Areas of use for full System

- Pre-packed Cooked Meats
- Pre-packed Breakfast
- Ready Meals
- Bagged Salad
- Pre-packed Cheese



### Areas to use dividers only

- Yoghurts
- Fats
- Spreads

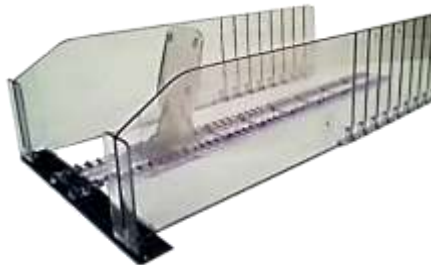

Support for Ladder  
Code: SPIVIRUG  
Size:60mm x 120mm

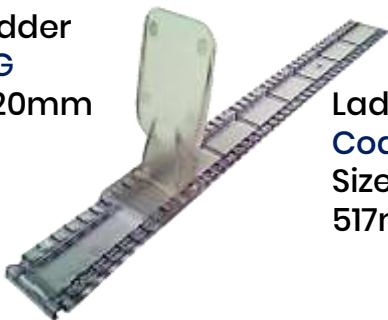

Ladder for Support  
Code: SPIVITRP  
Size: Adjustable from 517mm To 150mm

Magnetic "T" Rail for use when fixing shelf management in place.

Code: MAGNETIC T RAIL  
Size : 1240 mm



Breakable T Divider 120 mm high with "T" Front Size: available to suit shelf depths 300 up to 500  
Code:VI25 - 485



## Why SimpleClick Universal?

# Designed for Medicinal, Vitamin & Personal Care

- Better Presentation Promotes Impulse Sales.
- Reduce Costs, Less Labour Intensive.
- Improve Stock Rotation & Reduce Waste
- Front Facing, Better Shop-Ability for Customers
- Better Visibility of Range.
- Allows shopper to find product easily.
- Instant Identification of off sales.
- Improve Category & Store Image.
- Designed to push Box, Round & Oval shapes.



For other categories or mixed shelves..... irrespective of shape. Simply count the facings or take a snapshot of the bay or category that you would like to manage and send it to [sales@alliedpointofsale.ie](mailto:sales@alliedpointofsale.ie) with your query and contact details.





# Front Facing For All .....

All Shapes on the one shelf. Box, Round or Oval Shape, Tubs & Tubes.

## One System with Maximum Possibilities .....

Push feed the products you want to, with single facings and a pusher. Then switch to divide by variant (multiple facings before the next divider).

Merchandise all ways on the one shelf with the one system.



Category – Average Facings Per 1M Shelf	Parts Needed For Average Shelf within a Full Bay	Assembly Code
Medicinal & Vitamin – Push Feed. Average 13 Facings per 1000mm shelf by 470mm deep	U Channel T Rail x 2 – Divider x 14 – Fixing Ledge for Divider x 14 – 4N Strength Spring Pusher x 11 – 6N Strength Spring Pusher x 2	CPPF MED&VIT
Medicinal & Vitamin – Divide By Variant only. Average 7 variants per 1000mm shelf.	U Channel T Rail x 2 – Divider x 8 – Fixing Ledge for Divider included in cost of the divider.	CPVAR MED&VIT

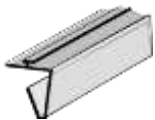

**Universal U-channel profile.** U-channel profiles can be used for all shelves with a front and back of shelf “U” channel. For 1 Meter Shelves  
Code: CP PD-4141

**Universal Base “T” Divider** 60mm For use when pushing products to provide automatic facings. Can be used with below divider as front profiles are identical. For use on a 470mm deep shelf. Fixing Ledge Not Included. Code: CP PD-7485

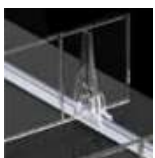
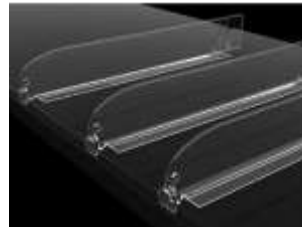

**Fixing Ledge** For use with above divider to locate or fix the divider to the channel at the back of the shelf.  
Code: CP PD-1505

**Pusher & Front Stop** For use on all products with a minimum width of 25mm. As product is supported with the special base T divider, there is no rail required for the base of the pusher. The 4N strength spring is suitable for all medicinal box shapes & the 6N strength spring would be for other products in this section, such as Tubs or round shape.

4N Code: CPZF-8504 Pusher 25mm, 4N suitable for 60gr

6N Code: CPZF-8506 Pusher 25mm, 6N suitable for 100gr

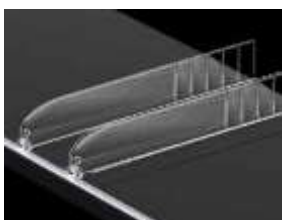

**Universal Breakable Divider H 60mm for 370mm & 470mm shelves.** For use when just dividing products by variant, for managing shelf plans or stockholding. Can be used alongside above “T” divider as front profiles are identical. Price includes rear fixing ledge. Breakable from 285 to 485mm  
Code: CP PD-6001





Category – Average Facings Per 1M Shelf x 470mm shelf	Parts Needed For Average Shelf within a Full Bay	Assembly Code
Hair Colours – Average 11 Facings Per 1000mm shelf (BASE T DIVIDER)	U Channel T Rail x 2 – Divider x 12 – Fixing Ledge for Divider x 12 –6N Strength Spring Pusher x 11	CP HAIRCOL
Deodorants – Average 17 Facings Per 1000mm shelf (BASE T DIVIDER)	U Channel T Rail x 2 – Divider x 18 – Fixing Ledge for Divider x 18 –6N Strength Spring Pusher x 17	CP DEO
Personal Care Average if dividing by variant (No Push Feed) individual facings. Average 11 dividers per shelf. 1000mm wide by 470mm deep. (STANDARD DIVIDER)	U Channel T Rail x 2 – Divider x 11 – Fixing Ledge for Divider x 11 Note – No push feed as this option is just to manage on shelf plan and stock.	CP PCARE Variant.

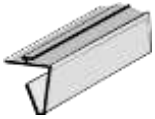

**Universal U-channel profile.** U-channel profiles can be used for all shelves with a front and back of shelf “U” channel. For 1 Meter Shelves  
Code: CP PD-4141

**Universal Base “T” Divider** 60mm For use when pushing products to provide automatic facings. Can be used with below divider as front profiles are identical. For use on a 470mm deep shelf. Fixing Ledge Not Included. Code: CP PD-7485

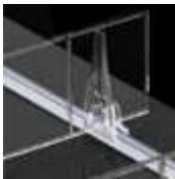
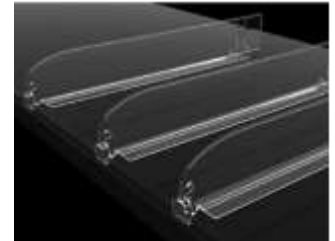

**Fixing Ledge** For use with above divider to locate or fix the divider to the channel at the back of the shelf.  
Code: CP PD-1505

**Pusher & Front Stop** For use on all products with a minimum width of 25mm. As product is supported with the special base T divider, there is no rail required for the base of the pusher. The 4N strength spring is suitable for all medicinal box shapes & the 6N strength spring would be for other products in this section, such as Tubs or round shape.  
4N Code: CPZF-8504 Pusher 25mm, 4N suitable for 60gr  
6N Code: CPZF-8506 Pusher 25mm, 6N suitable for 100gr

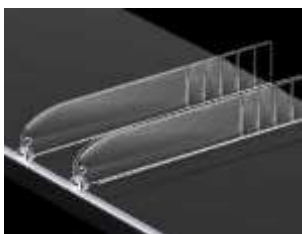

**Universal Breakable Divider H 60mm for 370mm & 470mm shelves.** For use when just dividing products by variant, for managing shelf plans or stockholding. Can be used alongside above “T” divider as front profiles are identical. Price includes rear fixing ledge. Breakable from 285 to 485mm  
Code: CP PD-6001



# SimpleClick Universal Nut & Seed Packs



Category – Average Facings	Parts Needed For Average Shelf within a Full Bay Per 1M Shelf x 470mm shelf	Shelf Assembly Code
Nuts & Seeds – Push Feed Average 11 Facings Per 1000mm shelf	U Channel T Rail x 2 – Base T Divider x 11 – Fixing Ledge for Divider x 11 – 14N Strength Spring Pusher x 10	NUT&SEED Push
Nuts & Seeds – Divide Only. Average 11 Facings Per 1000mm shelf	U Channel T Rail x 2 – Standard Divider x 11 including Fixing Ledge	NUT&SEED Divide

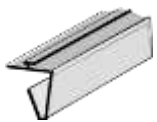

**Universal U-channel profile.** U-channel profiles can be used for all shelves with a front and back of shelf “U” channel. For 1 Meter Shelves  
Code: CP PD-4141

**Universal Base “T” Divider** 60mm For use when pushing products to provide automatic facings. Can be used with below divider as front profiles are identical. For use on a 470mm deep shelf. Fixing Ledge Not Included. Code: CP PD-7485

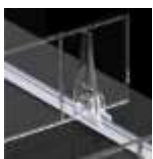

**Fixing Ledge** For use with above divider to locate or fix the divider to the channel at the back of the shelf.  
Code: CP PD-1505

**Pusher & Front Stop** For use on all products with a minimum width of 25mm. As product is supported with the special base T divider, there is no rail required for the base of the pusher. The 4N strength spring is suitable for all medicinal box shapes & the 6N strength spring would be for other products in this section, such as Tubs or round shape.

4N Code: CPZF-8504 Pusher 25mm, 4N suitable for 60gr  
6N Code: CPZF-8506 Pusher 25mm, 6N suitable for 100gr

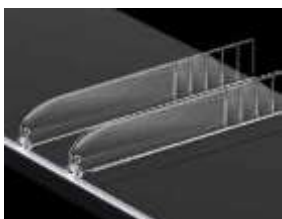
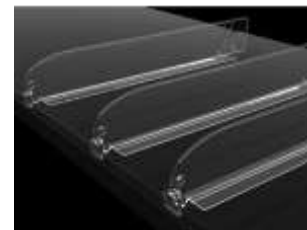

**Universal Breakable Divider H 60mm for 370mm & 470mm shelves.** For use when just dividing products by variant, for managing shelf plans or stockholding. Can be used alongside above “T” divider as front profiles are identical. Price includes rear fixing ledge. Breakable from 285 to 485mm  
Code: CP PD-6001



## NEW FORMAT Shelf Talkers

PVC Shelf Talker sleeve which slots into 39 high shelf edge front strip. Areas of use are, Front Of Store Fridge & Bakery Take Home Display.

Size:  
115mm by 65mm

Code:  
PRET 03

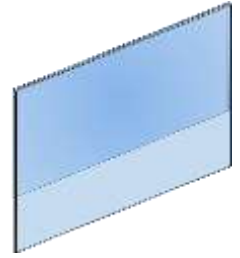

## NEW FORMAT Serve-Over Shelf Talkers



MEAT & FISH COUNTER SPECIAL OFFER HOLDERS

2 pieces of 0.7mm PVC material that fit into each other, one flat & one with a fold. This make up allows for easier cleaning.

Size: 77mm high x 115mm long. PACKED IN BUNDLES OF 20

Code: PVC 56

## Wooden Shelf Talkers Bakery A6 Wooden Shelf Talker



Birch Ply A6 Landscape Shelf Talker Holder (sealed for food safety). Comes with back piece for inserting into SEL rails as shown (left). Open slot on side for inserting messages. Code: WOD 20



## A6 Plus Stand Options



Birch Ply A6 Table Top Holder. Can be used as a shown for counter top, by inserting a leaning insert. High & Low options available and Open slot on side for inserting messages.

Standard L Code: WOD20+L  
Tall (+ 80mm on L) Code: WOD20+TL



## Craft Beer Wooden Shelf Talker



Birch Ply Craft Beer Shelf Talker Holder (sealed for food safety). Comes with back piece for inserting into SEL rails. (Chalkboard insert not inclusive) Open slot on top side for inserting messages. Overall size 170mm wide by 72mm high. Visible window size 146mm by 48mm. Code: WOD 22



# Treat Holder Price Stand



Stand Alone Reverse Angled Black Stand, for use at front of store "Treat Display".

Ticket Holder Size:  
115mm x 65mm (Angled Face)

Code:  
HIP 02

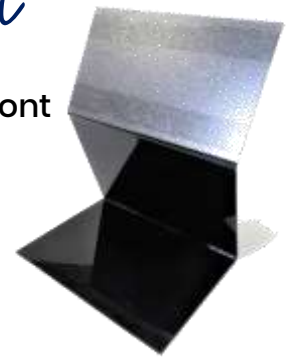

# Shelf Talkers With Hinge

Hinged Shelf Talker for use with inserts that are printed in store.

Size: 1/3 A4 Code: WST 103 x 210 C  
 Size: 1/6 A4 (6 up) Code: WST 77 x 153 C  
 Size: 1/4 A4 Code: WST 77 x 210  
 Size: 1/2 A4 Code: WST 106 x 297  
 Size: Code: WST 106 x 270

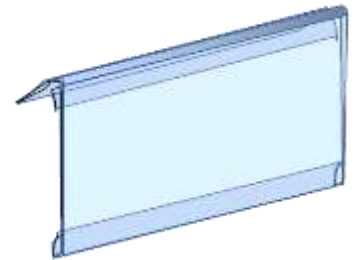

For width variations, please enquire with our office.

# Shelf Talkers (Non Hinged)



PVC Shelf Talker with no hinge. 39mm reveal at top for fitting into shelf data strip.  
 1/3 A4 Code: DLST  
 A4 Portrait Code: STA4



# Bus Stop Clip



Bus Stop Clip Holder for holding shelf edge flag.  
Code: BSC60

Print sold separately

# Freezer Shelf Talker

Shelf Talker which sits over freezer dividers to highlight special offers right at the Point Of Purchase. Size: 1/3 A4

Code: ST103x210 FREEZ



# Glass Shelf Talkers



Shelf Talker with suction cups for use with inserts that are DL size (1/3 A4) For use on glass. Size: 1/3 A4  
Code: ST103x210GLASS

# Fruit & Veg Talker

Shelf Talker which sits into F&V Angled Trays, highlighting special offers at the Point Of Purchase.

Size: 600mm by 105mm Message  
Code: PVC 06



# Shelf Fronts Main Floor Metal Shelving

**RECOMMENDED** One position clip on data strip, **specially designed to accommodate variances** of metal fronts for main floor Tego, Eden or RADFORD dry grocery metal shelving.

Length: 988mm Code: TER39-colour-988

Length: 1238mm Code: TER39-colour-1238

Colours: Clear, Cream & Silver

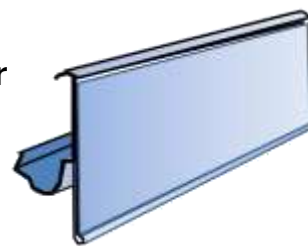

**Value Option** One position transparent clip on data strip, for main floor Tego, Eden style shelving dry grocery metal shelving.

**NOTE : there are many variations in metal shelf fronts, please check samples on a number of shelves before purchase. Resprayed shelving could be an issue for this strip.**

Length: 988mm Code: TEN39-clear-988

Length: 1238mm Code: TEN39-clear-1238

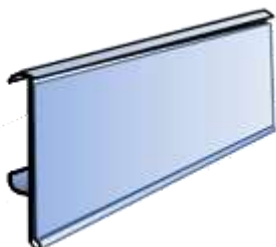

Slide on data strip for Hansa Mertens Main Floor flat Metal shelving, Colours available Black & Silver

Code: MGW39/Silver or Black/1187

Code: MGW39/Silver or Black/ 987

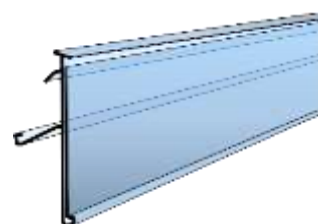

## Shelf Edge Stick On Fronts

Stick on data strip for fridges and other areas, possibly Fruit & Veg

Length: 990mm Code: WSF39TP-Clear-990

Length: 1240mm Code: WSF39TP-Clear-1240

Length: 990mm Code: WSF39TF-White-990

Length: 1240mm Code: WSF39TF-White-1240

Length: 1240mm Code: WSF60TF-White/Clear-1240

Tape: Foam tape (TF) / Clear Tape (TP)

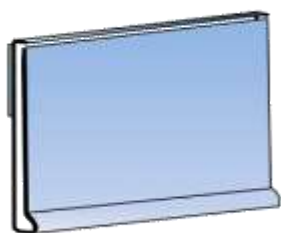

## Shelf Fronts Fridges

White, clear or silver-Clip on data strip for Linde Refrigeration Shelves, White replacement Clips are also available as below.

Length:  
1240mm

Code:  
TER39-colour-1240

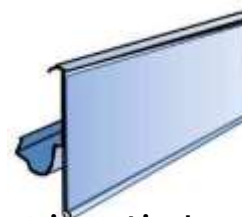

Clip for shelf edges on Linde Fridges. Used to attach data strip to Linde Refrigeration shelves. Colour: White Code: 9134691

Clear Data Strip with swinging hinge for fridges with oval bar front, use in Costan Fridges. Length: 1240mm Code: WC-CLEAR-1240

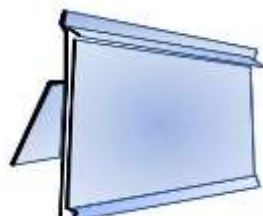

Data Strip for fridges with "C" Channel receiver, use in Chilled Fridges

Length: 1240mm

Colour: Clear/White

Code: WVF39-colour-1240

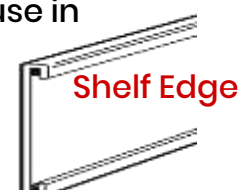

Shelf Edge



# Shelf Edge Fronts Freezer Door Wire Shelves



Clip Over data strip for Freezer Door wire shelves, colour white and label height for 39mm or less

Length:  
750mm  
590mm

Code: WBEG39-750  
Code: WBEG39-590



## “U” Shelf Front

# Shelf Fronts For U Shaped Front

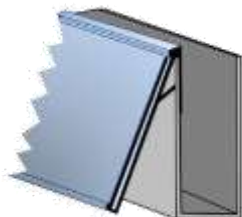

Clip over data strip 39mm high for use on any shelf that has an edge as shown in the drawing to the left.

Length: Colour: 1240mm  
Code: WRF39-1240

# Coloured Shelf Edge Inserts

Shelf Edge Coloured Insert Rolls to suit 39mm high Data Strips. Colours as shown Black, Green & Red.

Code: Height/Length:  
ROLLS OF BLACK INSERT 39mm / 100 Meters  
ROLLS OF GREEN INSERT 39mm / 100 Meters  
ROLLS OF RED INSERT 39mm / 100 Meters



# Acrylic Shelf Risers Main Floor

Biscuit Stop 30mm High (Shelf Riser) for Tego or Eden Shelving only. Material Acrylic

Length: Code:  
652mm ACR 29  
987mm ACR 31  
1237mm ACR 30  
537mm ACR 46

30mm High Biscuit Stop



Shelf Riser 70mm High (Shelf Riser) for Tego or Eden Shelving only. Material Acrylic

Length: Code:  
652mm ACR 34  
987mm ACR 32  
1237mm ACR 33

70mm High Riser



# Acrylic Shelf Risers Refrigeration

Refrigeration Shelf Riser 105mm or 80mm High and 1250 Wide Material Acrylic. **SUITS ALL 3,4 & 5 PIN SHELVES**

Code: ACR 43 Size: 80mm H (above shelf) by 1250mm W  
Code: ACR 44 Size: 105mm H (above shelf) by 1250mm W

80mm or 105mm High Riser (above Shelf)

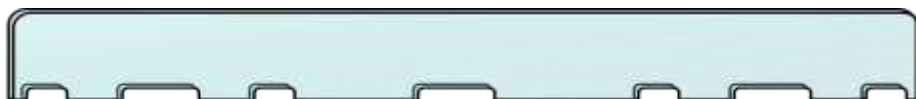

# The Vintage Look Tram - Cart & Accessories

Market cart made of high-quality natural mango wood

- Make a Statement
- Attract Attention
- Promote Impulse Sales
- Flexible and quick to install.
- Mobile, easy repositioning.
- Weather-resistant,
- High End Presentational Feature Display

The dimensions of the Standard are H 820mm W 1500mm D 800mm. The Chassis is black with solid black lacquered finish with solid rubber tyres. Material for cart top is mango wood colourless lacquer & metal edged corners. Code: TM BASIC



## Classic Model



## Basic Model



For more options and to view to the full range, contact our office for further details.

The dimensions of the Classic Model carts are H 820mm W 1700mm D 750mm. The shelf size is H 450mm W 1680mm D 450mm. The chassis is black with solid rubber tyres. The unit has a weight loading of maximum 100KG. Capacity of top 1.9 Square Meters. Code: TM CLASSIC

Add extra dimension to your display with the additional shelf. It can be situated on the cart as shown or on the floor in front of the wheels to create a tiered effect. Code: TM CLSHELF

Still looking for More.....Canopy Cover. Canopy Top comes in a choice of colours & materials, with flat or wave edging finish, for variation options, please contact our office. The dimensions of the above canopy structure is H 1230mm W 1750mm D 1040mm. When fitted the distance from the ground to the top of the canopy is 2050mm. Code: TM CO-COVER





*Versatile, Eye-catching, high impact Feature Display Table.*  
**Ideal for creating a rustic or premium look & feel to any product range, promoting impulse purchasing.**

**MINI Mid Floor Feature Display Table.** Each Table comes with four 200mm D shelves by 665mm W & 1 by Goal Post Graphic holder (sign not included) . Shelves can be mounted to the front, back, sides or below Graphic on Goal Post. Finish is black powder coated on all metal parts & legs are fitted with self levelling feet. Unit Dimensions not inclusive of shelves H 1470mm x W 665mm x D 665mm Note - Shelves in situ, increase dims by 200mm on each side. Complete Table with 4 shelves, Goal Post with 2 hooks to hold sign & wood top

Code: TB 665 COM

**Extra Metal shelves can be ordered, details below.**

Trough Metal 665 Shelf Code: TB MET SH 665

Standard



Standard Set as per image on the left..... If you would like to explore other options as shown on the right, contact our office for further details.

Modified



Standard



**MAXI Mid Floor Feature Display Table.** Each Table comes with four 200mm D shelves by 1000mm W, 1 by 665 shelf x 200 D & 1 by Goal Post Graphic holder . Shelves can be mounted to the front, back, sides or below Graphic on Goal Post (sign not included). Finish is black powder coated on all metal parts & legs are fitted with self levelling feet. Unit Dimensions not inclusive of shelves H 1470mm x W 665mm x D 1025mm Note - Shelves in situ, increase dims by 200mm on each side. Optional Add-On of front table with 3 shelves, can be used to extend the display when busy and reduce the display when stocks are low..

Complete Table Set Code: TB 665-1000 COM + TB - SMALL

**Extra Metal shelves can be ordered, details below.**

Trough Metal 665 or 1000mm Shelf

Code: TB MET SH 665

Code: TB MET SH 1000

MAXI SET



Small stand can be tucked under front display when stock reduces



MAXI SET



# The Vintage Look – Serious About Theatre

Eye-catching, high impact feature displays. Ideal for creating a rustic or premium look & feel to any product range.



Iron and Reclaimed Timber Trolley With 2 Metal Baskets. Dimensions: 900mm x 900mm x 500mm  
Code:BU-13

Iron and Reclaimed Timber Trolley With 3 Metal Baskets. Dimensions: 900mm x 1200mm x 500mm  
Code:BU-14



Iron and Reclaimed Timber Trolley With 4 Metal Baskets. Dimensions: 900mm x 1500mm x 500mm. Code:BU-15

## The Vintage Look – Floor Stands

Vintage Look & Feel Feature Display. Three angled removable trays. Trays are branded with printed fronts, Lavender / Staples Bros / Charles Jones. Display & highlight produce, in an imaginative and memorable way. Size: H 1150mm W 670mm D 350mm Code: BX058  
(If being used for unpackaged foods a food grade liner must be used)



Vintage Look & Feel Feature Display. Three angled removable box/crate trays. Trays are branded with printed fronts. Display & highlight promotional or seasonal produce, in an imaginative and memorable way. Size: H 1350mm W 670mm D 370mm Code: BX059  
(If being used for unpackaged foods a food grade liner must be used)

Vintage Look & Feel Feature Display. Six angled removable rectangular handled boxes. Boxes are branded with printed fronts, Black & White / Dewars White Label / Homers Ginger & Brandy . Display & highlight products, in an eye-catching way. Size: H 1350mm W 670mm D 400mm  
Code: BX057  
(If being used for unpackaged foods a food grade liner must be used)



# Vintage Look *Artisan Display* Props & Stands

Mid Floor Feature Display, Flat Top Cart. Vintage Stained colour giving you the perfect focal point. Display & highlight promotional or seasonal produce, in an imaginative and memorable way.

H 720mm W 1000mm & Front to Back: 1500mm  
Code: BX-098

(If being used for unpackaged foods a food grade liner must be used)



3 Tier Hand Trolley Display. Display & highlight products, with this vintage eye-catching display. Size: H1350mm W850mm D600mm. Code: BX096

(If being used for unpackaged foods a food grade liner must be used)

3 Tier Crate Display with Chalk Board Header . Three angled crate shelves. Crate fronts are branded, A.E. Williams. Display & highlight products, with this vintage eye-catching display. Size: H 1750mm W 390mm D 605mm Code: BX094

(If being used for unpackaged foods a food grade liner must be used)



3 Tier Hand Trolley Open Crate Display. Display & highlight products, with this vintage eye-catching display. Size: H1200mm W650mm D580mm. Code: BX097

(If being used for unpackaged foods a food grade liner must be used)

4 Seater Iron & Wood Table with adjustable swivel seating. Can be used for seating or in creating an Eye Catching Centre Piece or for a Feature Display. Dimensions: 760mm x 1300mm x 900mm. Code:BU-06

(If being used for unpackaged foods a food grade liner must be used)



Iron Milk Churn. Helping to create that particular visual experience for your customers. Size: 380mm x 560mm x 380mm. Code: HK 1872

A Pair of Original Iron Measuring Jugs. Pack of 2 Size: 260mm x 600mm x 200mm. Code:SB 179



Helping to create atmosphere. Original Iron Vintage Weighing Scales. Size: .310mm x 260mm x 260mm. Code:SB 486



# The Vintage Look - Serious About Theatre



Hessian Sacks for use in enhancement of Fruit and Veg displays. Big enough to fit around fruit and veg crates and give a perfect tidy and artisan looking display effect. Size: 800mm X 1000mm Code: Hess 80x100

(If being used for unpackaged foods a food grade liner must be used)



Hessian Rolls for use in enhancement of displays. Hessian Material (Medium Grade (305GSM)) per 50 mtr Roll. Give your display a taste of the artisan look and feel. Size: 1.83M by 50M Code: Hess Roll

(If being used for unpackaged foods a food grade liner must be used)



Wood wool is a great lightweight packing material - great for hamper, gift and retail display. 13.5 cubic foot approx. Lightweight & Eco Friendly solution. Code: WOODWOOL

(If being used for unpackaged foods a food grade liner must be used)



Rustic Vintage Wooden Lidded Chest Box. Branded with San Lorenzo, Finest Olive Oil or Thomas Wood Co. Boston Importers Packaged Teas Create atmosphere or that something special to feature displays.

Size: H 220mm W 360mm D 250mm

Olive Oil Code: BX-032-OO

Thomas Wood Code: BX-032-TW



(If being used for unpackaged foods a food grade liner must be used)



Vintage Wooden Serving Trays. Branded with Brancaster Mussels. Set of three nesting handled trays. Create atmosphere & add to the overall look & feel of your selling space. Size: H 220mm W 360mm D 250mm

Code: BX-036-BM

Rustic Display Box, Set of 4. Branded with Moët & Chandon-Imperial Ice. Create atmosphere & add to the overall look & feel of your displays.

Size: H 280mm W 270mm D 175mm (outside)

Code: BX-053-II



(If being used for unpackaged foods a food grade liner must be used)



Rustic Display Nesting Oyster Box Set, Set of 5. Mix of branded prints. Create atmosphere & add to the overall look & feel of your displays. Size: H 125mm W 355mm D 285mm (outside)

Code: BX-027-TW



# Imitation Cheese Props

Create Full Charcuterie displays without the continued cost of the extra stock. Effective displays promote impulse purchases, while reducing the risk of waste.



Imitation Cheese Wheel Blue. Size: 40mm by 240mm Diameter Code: CP-KD1043

Imitation Cheese Wheel Kernhem. Size: 55mm by 245mm Diameter Code: CP-KD1016



Imitation Cheese Wheel Red. Size: 40mm by 240mm Diameter Code: CP-KD1042

Imitation Cheese Wheel White. Size: 42mm by 248mm Diameter Code: CP-KD1041



Imitation Castello Blue. Size: 53mm by 200mm Diameter Code: CP-KD1023

Imitation Cheese Wheel Brie. Size: 39mm by 333mm Diameter Code: CP-KD1004



Imitation Cheese Chaumes. Size: 45mm by 235mm Diameter Code: CP-KD1009

Imitation Saint Albray. Size: 50mm by 250mm Diameter Code CP-KD1008



Imitation Port Salut. Size: 60mm by 200mm Diameter Code: CP-KD1006

Imitation Parmigiano. Size: 210mm by 440mm Diameter Code: CP-KD10336

Imitation Grana Padano. Size: 210mm by 440mm Diameter Code: CP-KD10337



Imitation Fontina. Size: 60mm by 360mm Diameter Code: CP-KD10352

Imitation Hollander. Size: 110mm by 150mm Diameter Code: CP-KD10333



Imitation Parmesan with inside bowl. Size: Life Size Realistic 210mm by 440mm. Code: CP-KD10348

Imitation Cheese Cut Pieces. Size: Life Size Realistic 200mm by 450mm. Code: CP-KD17582



Imitation French Cheese Assorted. Size: Life Size Realistic 200mm by 450mm. Code: CP-KD10350



# Imitation Food Props

Create Full Charcuterie displays without the continued cost of the extra stock. Effective displays promote impulse purchases, while reducing the risk of waste.



Green, Yellow or Red Peppers, (set of 3). Size: 85 x 110mm  
Green Code: CP-KD07248 set of 3  
Yellow Code: CP-KD07250 set of 3  
Red Code: CP-KD07251 set of 3

Lemon Half X 3 set  
Size: 40 x 35mm  
Code: CP-KD01052



Bunch Of 6 Radish  
Size: 35 x 130mm  
Code: CP-KD07260



For Enquires on any other food prop products, please contact our office on 01 4587470 or send an email to [sales@alliedpointofsale.ie](mailto:sales@alliedpointofsale.ie)



Imitation Parma Ham. Size: Life Size Realistic – 270mm by 480mm. Code: CP-KD12364

Imitation Salami White with Net, Set of 2. Size:- 50mm by 250mm Code: CP-KD12372



Imitation Salami Red with Net, Size:- 50mm by 250mm Set of 2 Pcs. Code: CP-KD12372



Imitation Red Grapes . Size: Life Size Realistic – 160mm Set of 6 pcs Code: CP-KD02112



Green Leaf Garland. Size: 2000mm L  
Code: CP-KD21672

Green Leaf & Lemon Garland.  
Size: 2000mm length  
Code: CP-KD21663



Parsley Garland.  
Size: 2700mm length  
Code: CP-KD21682



Garlic 20 pc Garland.  
Size: 500mm length  
Code: CP-KD20637



# Imitation Fish Counter Props

Create Full Charcuterie displays without the continued cost of the extra stock. Effective displays promote impulse purchases, while reducing the risk of waste.



Lobster Prop. Size: 300mm by 130mm Code 13402

Crab Prop. Size: 200mm x 130mm  
Code: CP-KD13423



Imitation Shells pack of 4 .Size: 120mm  
Code: CP-KD13410

Imitation Mussel String. Size:  
350mm Code: CP-KD19616



Imitation Shell String.  
Size: 350mm  
Code: CP-KD19615

Imitation Trout String.  
Size: 350mm  
Code: CP-KD19627



Imitation Sardines String.  
Size: 350mm  
Code: CPKD19624

Fishing Net Prop with 13 fish.  
Size: 2000mm by 1500mm  
Code: CP-KD13448



Creel Net Prop. With  
8 fish. Size: 470mm  
Code: CP-KD13447



Mini Assorted Fish Props.  
Number of pieces 24.  
Sized from 70mm to 120mm  
Code: CP-KD13458

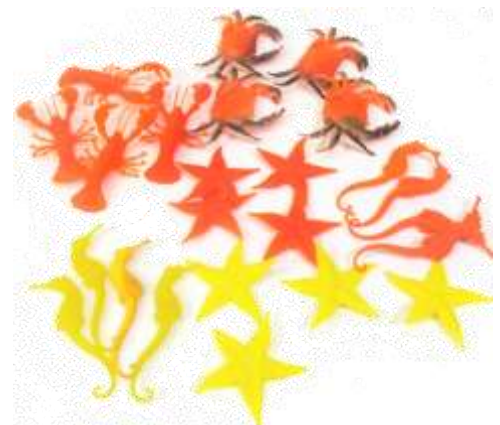

# Poly-Wicker Display

Grey Poly-wicker floor display baskets are food-safe, & washable. Ideal for creating impactful side displays and can be used in various areas around your store.. The set is made up of 2 large & 1 medium basket. The basket is woven around a steel frame for extra support. Large Basket Size: 700mm H x 580 Diameter top & 440 at bottom with a basket insert 600mm diameter with a depth of 230mm.

LG Basket & Top Code: PWGB LG .

Medium Basket Size: 500mm H x 450 Diameter top & 285 at bottom with a basket insert 600mm diameter with a depth of 230mm. MED Basket & Top Code: PWGB MED

Set of 2 large & 1 Medium Code: PWGB SET



Poly Wicker Ticket Holder. PETG hook over clip for Grey Poly Wicker Floor Displays. Ticket holder size is 115mm by 40mm high. Code:PWICKER TICKET HOLDER



## One Of Your *Five* A Day Floor Stand

Black Metal Floor Stand, comes with 3 Poly-wicker wedge shape baskets with rounded front (Food Safe). Promote additional sales while adding perceived value to your offering. Stand Size: 520mm Diameter by 1060mm High. Basket Size: 500mm x 350mm x 100mm  
Code:SP300+BT-1050



## Table Top *Multi* Tier Displays



Large 3 Tier

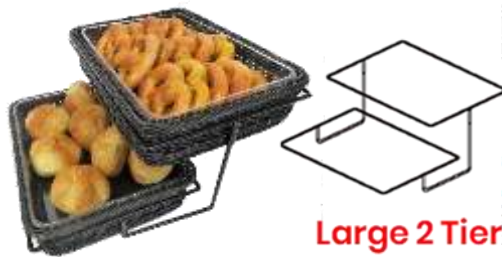

Large 2 Tier

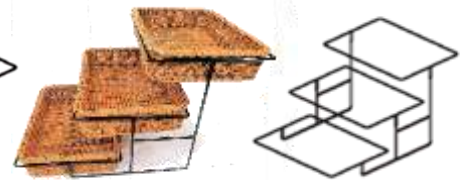

Small 3 Tier

Powder Coated Black Metal Frame Stand, supporting stepped Poly-wicker food safe display. Display will help promote additional sales while adding perceived value to your offering. Could also be used as a centre piece table display for highlighting seasonal offers or featured products. Chestnut colour Poly-wicker with Black powder coated frame.

3 Tier Large: H 380mm x W 400mm x D 620mm -

2 Tier Large: H 220mm x W 400mm x D 480mm -

3 Tier Small: H 320mm x W 305mm x D 520mm -

Code:TC-019

Code:TC-019-B

Code:TC-018



## Get Creative

## With Tier Displays





# Artisan Display Wicker

Black Poly-wicker baskets are food-safe, dishwasher-proof and suitable for use in chilled cabinets. Comes with a hand washable food safe liner. (Also ideal for counter top displaying of products. Size: 70mm H x 400mm by 300mm Code: PLO26



Brown Poly-wicker baskets are food-safe, dishwasher-proof and suitable for use in chilled cabinets. Comes with a hand washable food safe liner. Also ideal for counter top displaying of products. Size: 70mm H x 400mm by 300mm Code: PLO25



Hygienic cover for counter-top Poly-wicker baskets. This cover is designed specifically to fit the counter-top baskets above. The cover is made from a food safe durable material. Standard & opening roll-top versions available. Standard Code: PC-007 Roll-top Code: PC-005



Clear Clamp for use with standard frames. Can be clipped onto the wicker baskets as shown. Could also be used with a chalk board insert for a more Artisan look & feel. Frame & Insert are not included but can be found with Frame Accessories. Code: 9173219



Step for enhancing your produce displays. Can be used in a wide range of places as the poly wicker finish is food safe. Size: D 400 x W 300 x H 120mm Code: MT - 1004



## Baguette Holder Baskets & Display Steps

The Round Food Safe Poly Wicker reinforced with a food grade stainless steel frame. Size: 290mm Diameter x 500mm Height Code: TO-008



The Spiral Food Safe Poly Wicker reinforced with a food grade stainless steel frame. Size: 280mm Diameter x 580mm Height Code: TO-1032





## Counter Stand 3 Tier

One 3 Tier stand – Many Combinations. Versatility to hold food safe Lined Poly Wicker Baskets, Food Safe Lined Wood Trays or food safe Melamine Platters. Construction – Metal-framed 3 tier display. Height: 380mm Width: 400mm & Front to Back: 700mm Stand Only Code: MET 71

*Optional* Current products that can be used in conjunction with the 3 Tier stand....listed below

Product On Page 23



Product On Page 27



Product On Page 31



## Counter Stand 2 Tier



This metal-framed 2 tier counter top display is designed to carry Poly Wicker Baskets, Slatted Wood Crates or Slate Boards (SP202) on each Level, creativity with versatility. Height: 32cm Width: 38cm Front to Back: 38cm Stand Only Code: MET 70



*Optional* products that can be used in conjunction with the 2 Tier stand....listed below

Page 23



Page 29



Page 31



## *Inspiration* Use Stackable Crates To Build Tiers

Stackable Crates to create tiered displays. Natural Finish. Size: 400x300x100mmH. Single Crate Code: WS 690

Crate also shown on Page 31

Food Grade Infill Liner Available



# Display Risers

Wire Cube Riser for product displays. For use with all platters, plates, or slate boards. Ideal for creating tiered presentation within serve-over or on feature displays. Dimensions 109mm H x 179mm x 168mm. The sizing allows for the riser to be used with all platters within this catalogue. The riser is coated with black nylon to help with non slip locating of platters.

Code: MET 72



## Milking Stool Tiered Displays Sets

Wooden milking display stool sets, designed to enhance product displays, in a natural finish: Sizes/Heights in set. 100 (S), 150 (M) & 200mm (L) high. Tops made from 18mm Ply with a diameter of 300mm 4 Legs for extra support. 25mm Dia. Unstained, Natural Finish Set of 3 Code: WS623

Rustic Brown Set of 3 Code: WS623RB

(If being used for unpackaged foods a food grade liner must be used)



Melamine Large Round Platter for above display stools. This food safe platter is self locating to the display stools as a round ridge on the base of the platter fits over the circumference of the stool top. Size: 350mmD by 20mm H. Colour: White Code: MELKUL 100035



## Mini Pallet Displays Sets

Mini Display Pallets –ideal for displaying food on a counter top! 3 sizes in set. Small – 265 x 163 x 70mm Medium – 325 x 265 x 70mm Large – 354 x 325 x 70mm. Made from raw wood (Pine) Perfect for shop displays.

Natural Finish Set of 3 Code: WS613

Rustic Brown Set of 3 Code: WS613RB

(If being used for unpackaged foods a food grade liner must be used)



## A Frame 3 Tier Floor Stand

Rustic wooden ladder display is perfect for product feature displays, or product high lighting. Overall height is approx. 1400mm and shelves are 1000mm, 750mm & 500mm x 400mm Deep.

Chunky Pine Board, with easy to remove shelves. The frame folds up for easy storage when not in use.

Picture is White Wash finish, also available in Natural & Dark Oak, please enquire to sales team in our office on 01-4587470 for further details.

White Code: WC605G-W

Dark Oak Code: WC605G-D

Natural Code: WC605G-N

(If being used for unpackaged foods a food grade liner must be used)



# Presentational

## Display Platters



Display/Serving Platter. Material Melamine & Size 440mm by 305mm.  
 Colour, Cement.  
 Code: 530636  
 Colour, Turquoise Cherry.  
 Code: 530637  
 Colour, Miocene.  
 Code: 530638



**Collection Details**

- 100% food safe
- not microwave safe
- dishwasher safe
- heat resistant (-10° - 110°C)
- maker design
- 2 yr breakage warranty
- BPA free product
- stackable design

Display/Serving Platter. Material Melamine & Size 530mm by 200mm.  
 Colour, Bamboo.  
 Code: 530165  
 Colour, Granite Grey.  
 Code: 530164  
 Colour, Turquoise Cherry.  
 Code: 530166  
 Colour, Miocene.  
 Code: 530167



## Wood Effect Platters



Walnut

Melamine Wood Effect Handled Rectangular Presentation Platter. Finish as shown, Teak or Walnut.  
 Size: 500mm by 195mm  
 Code: 35040-col



Melamine Wood Effect Round Presentation Platter. 330mm by 300mm  
 Material Melamine. Code: 35033



Melamine Wood Effect Oval Presentation Platter. 530mm by 270mm  
 Code: 35053



Melamine Wood Effect Handled Round Presentation Platter. Finish Walnut.  
 Size: 300mm D by 420mm L.  
 Code: 35130



### Wood Effect Collection Details



## Transform Pebble Endure Display

Melamine Platter 400mm by 275mm RECTANGULAR  
PEBBLE ENDURE Code: 529799

Melamine Platter 280mm by 190mm RECTANGULAR  
PEBBLE ENDURE Code: 529790

Melamine Platter 350mm by 210mm RECTANGULAR  
PEBBLE ENDURE Code: 529808

Melamine Platter 270mm by 155mm RECTANGULAR  
PEBBLE ENDURE Code: 529735

Melamine Large Bowl 330mm D x 100mm H  
WHITE TRANSFORM Code: 530647

Melamine Medium Bowl 255mm D x 80mm H  
WHITE TRANSFORM Code: 530646



## Transform Wood Effect Display

Melamine Platter 400mm by 275mm RECTANGULAR  
Wood Transform Code: 529801

Melamine Platter 280mm by 190mm RECTANGULAR  
Wood Transform Code: 529788

Melamine Platter 350mm by 210mm RECTANGULAR  
Wood Transform Code: 529802

Melamine Platter 270mm by 155mm RECTANGULAR  
Wood Transform Code: 529780

Melamine Large Bowl 330mm D x 100mm H  
WOOD TRANSFORM Code: 530640

Melamine Medium Bowl 255mm D x 80mm H  
WOOD TRANSFORM Code: 530639

## Transform Pewter Endure Display

Melamine Platter 400mm by 275mm RECTANGULAR  
PEWTER ENDURE Code: 529800

Melamine Platter 280mm by 190mm RECTANGULAR  
PEWTER ENDURE Code: 529728

Melamine Platter 350mm by 210mm RECTANGULAR  
PEWTER ENDURE Code: 529804

Melamine Platter 270mm by 155mm RECTANGULAR  
PEWTER ENDURE Code: 529807

Melamine Large Bowl 330mm D x 100mm H BLACK  
TRANSFORM PE Code: 530645

Melamine Medium Bowl 255mm D x 80mm H BLACK  
TRANSFORM PE Code: 530644



# Polaris

Display Pan. Finish White Granite or Black Matt.  
Size: 240mm D by 410mm L.

White Granite  
Black Matt

Code: 38024WG  
Code: 38024B



Rectangular Display Platter 530mm by 325mm

Code: 41011WG  
41011BL  
Colour: White Granite  
Black Ripple

Rectangular Platter 325mm by 265mm

Code: 41012WG  
41012BL

Colour: White Granite  
Black Ripple



Rectangular Platter 325mm by 177mm

Code: 41013WG  
41013BL

Colour: White Granite  
Black Ripple

Rectangular Platter 530mm by 163mm

Code: 41024WG  
41024BL

Colour: White Granite  
Black Ripple

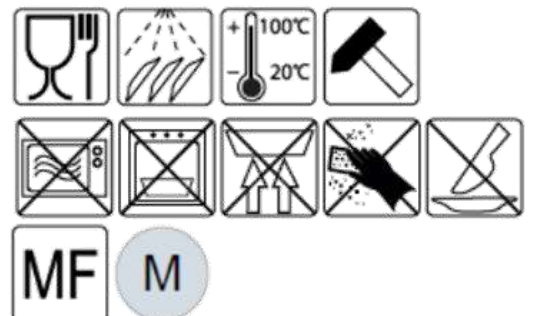

# DELI POS – *Natural Slate & Tasting Units*



Rectangular Natural Slate Platter. Natural Slate boards have an incredible variety of uses, as they are food-safe. Ideal for displaying or serving cheeses and other foods.  
W: 295mm L: 210mm Pack of 2 Code: SP202

Slate Platter with metal handles. Promote High margin products in style. Ideal for displaying or serving cheeses and other foods.  
H: 25mm W: 250mm L: 350mm Code: SP211



Two Tiered Round Natural Slate Platter. Treated to be completely food-safe and washable so you can display cakes, cheese, cooked meats and other produce with style and elegance.  
H: 240mm D: 250mm C Code: SP210

Mini Slate Heart Tags, are ideal for creating Artisan Feel with pricing or information display in-store. Made from natural slate, the hearts come with a small string to allow them to be tied.  
Size: H: 70mm W: 65mm Code: SP208



Natural Slate Board With Rope. Create the signs you need when you want them and hang them where they will have the most effect.  
Size: Height: 80mm x Width: 120mm Code: SP207

## Pizza Display Steps



Angled Step for display of Fresh Pizza. For use in Mid floor chilled units (Spider Units). The step is 300mm by 290mm in size and has routed slots on the base for airflow. The typical spider unit uses 9 steps per unit. Material - PETG 4MM Size - 300mm by 290mm  
Code: PET04

6 Facings deep upright pizza display. Material 5.0mm PTEG. Dims: 150mmW x 435mmD x 135mmH  
Code: PET-54



## Tasting Units



Food Sampling Unit - Clip On Tray.  
Dimensions 215mm W by 195mm D by 335mm H  
Code: ACRFSU-CLIPON

Food Sampling Unit - Stand.  
Dimensions 215mm W by 195mm D by 335mm H  
Code: ACRFSU COUNTER STAND



Food Sampling Stand, complete with holders for Napkins, Brochure Holder (DL), Toothpick Holder & Waste Bin. There is a 380mm diameter Dome Cover & Stainless Steel Tray. Colour is silver grey powder coated finish.  
Dimensions 400 D by 1200 H. The below cost does not include branded prints.  
Code: 57.0110.1

To Order Just the Top Dome - Roll - Top Hemisphere cover for Food Sampling Stand Code: 57.0121.1



# Vintage Look – Wine Displays & Bottle POS



Wine “Zig Zag” Bottle Display Rack. Eye-catching wall display, to highlight product or create atmosphere to overall look & feel of your off-licence. Holds 6 bottles. Size: H 825mm W 320mm D 110mm Code: BX-081

Wine Bottle & Glass Wall Display Frame. Eye-catching wall display, to highlight product or create atmosphere to overall look & feel of your off-licence. Display holds 4 bottles & 4 glasses. Size: H 800mm W 510mm D 140mm Code: BX-083



Wine 4 or 8 Bottle Wall Display Rack. Eye-catching wall displays to highlight product or create atmosphere to overall look & feel of your off-licence. Display holds 4 or 8 bottles wide.  
 4 Bottle Size: H 270 x W 470 x D 130mm Code: BX-022-H  
 8 Bottle Size: H 270 x W 915 x D 130mm Code: BX-020-H



## Bottle High-Lighters

Highlight Wines or Champagne with this eye catching three wine bottle display. Size - D 150mm x W 300mm H 400mm 90mm dia. Recessed Holes for product locating, Approx 20mm deep. Easy to Clean Designed for use with Stick Chalk or Chalk Pens Dark oak stain Holds 3 bottles of wine or Champagne. Add your own messages and promote your best offers or products..... Code: WC880

**Other variations of above available, just call our office for more information...**

Securit® Table or counter Bottle displays with chalkboard frames – to hold 1 or 3 bottles.  
 1 bottle Code: WB-WR-1 Dims:450 x 110 x 113mm  
 3 bottle Code: WB-WR-3 Dims:450 x 390 x 113mm



Securit® Bottle neck hanger in oval shape – Leather cord with chalkmarker included – set of 6  
 Set of 6 +  
 Code: TAG-BOTTLE  
 Dims: 50 x 83 x 20mm



Securit® Bottle neck chalk board tag – set of 10  
 Set of 10 Code: TAG-BO-WT  
 Dims: 50 x 83 x 20mm





# Wood Crate & Barrel Display

Wine Crates, the traditional 12 bottle crate, for perfectly tidy bottled wine displays. Size: 500x330x170 Code: WINECRATE  
(If being used for unpackaged foods a food grade liner must be used)



Softwood Display Crate. Size: 400 x 300 x 90mm H Designed for stacking/nesting with each other, or 2 to nest with WS689 (below)  
Code: WS 690

(If crates are being used for unpackaged foods a food grade liner must be used)



Softwood Display Crate. Size: 600 x 400 x 150mm H Designed for stacking/nesting with each other.  
Code: WS 689

(If being used for unpackaged foods a food grade liner must be used)



Short Half Whiskey Barrel with 1 shelf, stained with black bands and Matt varnish. Approximate Size: 900mmH x 650mmW x 325D Code: WBS HALF  
(If being used for unpackaged foods a food grade liner must be used)



Wine Barrel with 1 shelf, stained with black bands and Matt varnish. Approximate Size: 940mmH x 650mmD Code: WBS  
(If being used for unpackaged foods a food grade liner must be used)

Long Half Whiskey Barrel with 1 shelf, stained with black bands and Matt varnish. Approximate Size: 900mmH x 650mmW x 325D Code: LHWBS  
(If being used for unpackaged foods a food grade liner must be used)



Half Barrel Hourglass Display, stained with black bands and Matt varnish. Approximate Size:  
Large H780xD550 Code: HBH Large  
Medium H640xD470 Code: HBH Med  
Small H580xD370 Code: HBH Small  
(If being used for unpackaged foods a food grade liner must be used)

Half Barrel Trough Display, stained with black bands and Matt varnish. Approximate Size:  
Large H390xD550 Code: HB Large  
Medium H320xD470 Code: HB Med  
Small H290xD370 Code: HB Small  
(If being used for unpackaged foods a food grade liner must be used)



# Artisan Display

## Coloured Crates



Large Rustic Wooden Crates. These replica antique crates were originally manufactured to transport fruit, but are now seen as fantastic shop displays. These rustic oak stained crates come with the following spec: Sides & base made from 8mm rough-sawn Scandinavian pine slats. Plain as standard but Printing available (POR)  
Size: Large 500mm wide x 370mm deep x 260mm high.

Code: WTC106

Size: Medium 425mm wide x 310mm deep x 230mm high.

Code: WTC106M

(If being used for unpackaged foods a food grade liner must be used)

Large Rustic Tray with Handles. This single slat rustic tray has been based on the original fruit "keepers" tray. Sides & base made from 8mm rough-sawn Scandinavian pine slats. Sizes: W 500 x D 365 x H 85mm & available in Rustic Brown, Pale Blue, Sage Green or White Wash.

Colour:

Rustic Brown

Pale Blue

Sage Green

White Wash

(If being used for unpackaged foods a food grade liner must be used)

Code:

WTC152RB

WTC152PB

WTC152SG

WTC152WW



Medium Rustic Planter Crates with Handles. Planter crates are based on the traditional apple or "bushel" crate & are ideal for retail display. Sides & base made from 8mm rough-sawn Scandinavian pine slats with hand holes on short sides. External Sizes: W 400 x D 310 x H 170mm & available in Rustic Brown, Pale Blue, Sage Green or White Wash.

Colour:

Rustic Brown

Pale Blue

Sage Green

White Wash

(If being used for unpackaged foods a food grade liner must be used)

Code:

WTC113RB

WTC113PB

WTC113SG

WTC113WW



Large Rustic Planter Crates with Handles. Planter crates are based on the traditional apple or "bushel" crate & are ideal for retail display. Sides & base made from 8mm rough-sawn Scandinavian pine slats with hand holes on short sides.

External Sizes: W 520 x D 370 x H 290mm & available in Rustic Brown, Pale Blue, Sage Green or White Wash.

Colour:

Rustic Brown

Pale Blue

Sage Green

White Wash

(If being used for unpackaged foods a food grade liner must be used)

Code:

WTC115RB

WTC115PB

WTC115SG

WTC115WW



Slatted Rustic wooden crate is a great alternative to any retail shop displays. Extra Slat can be used for branding or just simply as a riser for bagged product or loose product displays. Finish is rustic brown and material is 8mm Scandinavian pine. Ideal Crate for stack displays.

Code: WTC106ST

(If being used for unpackaged foods a food grade liner must be used)



Portrait

## Large Shelved *Rustic* Crate



Now comes with a shelf making it perfect for shop displays, to feature or highlight products. Material is 8mm rough sawn Scandinavian pine. Crate size: W 500mm x D 370mm x H 260mm. The colour finish is Rustic Brown and there are two shelf options with landscape or portrait variants.

Landscape Shelved

Code:WTC170L

Portrait Shelved

Code:WTC170P



Landscape

## Create Your Own Unique Displays Using The Crate Bundles...

### Mixed Bundle Rustic Crate

pack makes for fantastic displays. Shop floor or window display - you name it they'll look the part. Pack consists of a Medium, Large & Extra Large Crate.

External sizes: D 255mm x W 350mm H

250/500/750mm. Made from three 8mm thick fine-sawn Scandinavian pine slats (60mm). Bases stained white as standard, finish is rustic oak colour as standard. For a secure and safe display, crates can be screwed together and/or fixed to a wall.

Bundle pack of three crates.

Code: WTC212



Standard Bundle Pack



3 Bundle packs needed to create the above display



### Extra Large Crate Bundle

These rustic oak finished crates make for fantastic featured product displays. Can be used in a number of ways from floor, to window or wall displays. This bundle pack consists of 6 extra large crates, made from 8mm Scandinavian pine slats, with a 6mm white ply backing. We would always recommend screwing crates together to secure display.

External crate sizes: D 255mm x W 350mm by H 750mm.

6 Crate Bundle

Code:WTC213G



### Large Crate Bundle

These rustic oak finished crates as above are recommended for featured product displays. Useful for floor, window or wall displays. This bundle pack consists of 6 large crates, made from 8mm Scandinavian pine slats, with a 6mm white ply backing. We would always recommend screwing crates together to secure display.

External crate sizes: D 255mm x W 350mm H 500mm

6 Crate Bundle

Code:WTC214G



# Table Chalkboard Accessories



Securit® Mini Table Sandwich Writable Sign, including chalk marker - set of 5 - Dims: 85 x 5 x 5mm  
Code: TAG-SBS-WT



Securit® Mini table chalkboard / Poster Holder - Plain lacquered wood. Dims: 250 x 152 x 20mm  
Code: SBS-B-MNI

Securit® Mini Easel table chalkboard - pack of 3 - Wood with lacquered black or Beech finish, with melamine chalkboard, Set of 3 pieces.

BLACK Dims: 244mm by 150mm by 135mm

Code: MNI-BL-KR set of 3:

BEECH Dims: 244mm by 150mm by 135mm

Code: MNI-B-KR set of 3:



Securit® Teak tag holder, including chalkmarker and A7 tags - Wooden - set of 6 - 90mm x 105mm x 30mm

Code: TAG-HLD-TE



Securit® Silhouette rectangle mini chalkboards, including chalkmarker - Wooden base - set of 4 - 7,5x9x2cm | 0,1kg  
Code: FBT-RECT-4



Securit® Chalkboard tag sets in sizes A4, A5, A6 & A7 including chalkmarker, 4 spikes - and 2 transparent holders

A4 Set of 5 Dims: 297 x 210 x 1mm

Code: TAG-A4-WT

A5 Set of 10 Dims: 210 x 148 x 1mm

Code: TAG-A5-WT

A6 Set of 20 Dims: 143 x 105 x 1mm

Code: TAG-A6-WT

A7 Set of 20 Dims: 105 x 74 x 1mm

Code: TAG-A7-WT



Securit® Spike tag holder - set of 20 (tags not included)  
Dims: 50 x 11 x 10mm Code: TAG-HOLDER-BL

Securit® Transparent tag holder - Acrylic - set of 10 (tags not included)  
Dims: 10 x 40 x 6mm Code: TAG-HOLDER-TR

Securit® Vertical L-shaped A5 table chalkboard. Frosted front with a gloss back - set of 3

A5 Set of 3 - Dims: 215 x 158 x 50mm Code: TBA-BL-A5

A6 Set of 3 - Dims: 155 x 105 x 50mm Code: TBA-BL-A6



Securit® Vertical L-shaped A6 table chalkboard. Frosted front with a gloss back - set of 5

A7 Set of 5 - Dims: 115 x 75 x 50mm Code: TBA-BL-A7

A8 Set of 5 - Dims: 70 x 75 x 50mm Code: TBA-BL-A8



## Pavement Boards - *Deluxe*



Securit® Sandwich hard wood pavement chalkboard with lacquered rubberwood frame. Dims: 850mm x 555mm x 545mm | 7,1kg Teak finish. Code: SBD-TE-85



Securit® Sandwich hard wood pavement chalkboard with lacquered rubberwood frame. Dims: 1250mm x 705mm x 570mm | 13,8kg Teak finish. Code: SBS-TE-120

## Pavement Boards - *Woody*



Securit® Duplo pavement chalkboard with lacquered pinewood frame. Dims: 850mm x 545mm x 440mm | 4,7kg Finish Black or Teak.  
Black Code: SBD-BL-85  
Teak Code: SBDW-TE-85



Securit® Duplo pavement chalkboard with lacquered pinewood frame. Dims: 1250mm x 690mm x 565mm | 8,3kg Finish Black or Teak.  
Black Code: SBS-BL-120  
Teak Code: SBSW-TE-120

## Pavement Boards - *Nature*



Securit® Sandwich pavement chalkboard with lacquered soft wooden frame with a rustic, natural finish.  
Finish Scaffold Wood. Dims: 1310mm x 722mm x 720mm | 11,6kg  
Code: SBS-N-135

## Wall Chalk Boards - *Woody*

Securit® Woody chalkboard, including white chalk marker and mounting kit. Lacquered Black or Teak finish.

Black Code: WBW-BL-20-24 Dims: 240 x 200 x 10mm  
Teak Code: WBW-TE-20-24 Dims: 240 x 200 x 10mm  
Black Code: WBW-BL-20-40 Dims: 400 x 200 x 10mm  
Teak Code: WBW-TE-20-40 Dims: 400 x 200 x 10mm  
Black Code: WBW-BL-30-40 Dims: 400 x 300 x 10mm  
Teak Code: WBW-TE-30-40 Dims: 400 x 300 x 10mm  
Black Code: WBW-BL-40-60 Dims: 600 x 400 x 10mm  
Teak Code: WBW-TE-40-60 Dims: 600 x 400 x 10mm  
Black Code: WBW-BL-60-80 Dims: 800 x 600 x 10mm  
Teak Code: WBW-TE-60-80 Dims: 800 x 600 x 10mm

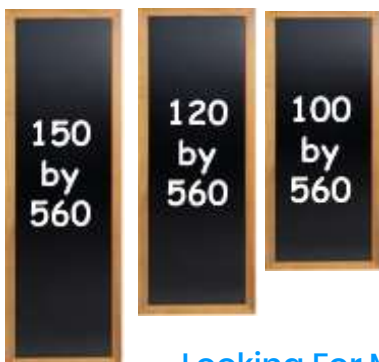

Securit® Long hard wood chalkboard - with lacquered teak finish - wall mounting screws included - 3 sizes  
Size: 100x560x25mm Code: WBL-TE-100  
Size: 120x560x25mm Code: WBL-TE-120  
Size: 150x560x25mm Code: WBL-TE-150



# Table Chalk Boards *Elegant*



Securit® Elegant large table chalkboard – Wood with lacquered black or Teak finish, with melamine chalkboard inserts, A4, A5 & A6 portrait.

BLACK A4 Dims: 323mm by 271mm by 70mm

Code: ELE-BL-LA

BLACK A5 Dims: 240mm by 200mm by 60mm

Code: ELE-BL-ME

BLACK A6 Dims: 174mm by 157mm by 50mm

Code: ELE-BL-SM



TEAK A4 Dims: 323mm by 271mm by 70mm

Code: ELE-TE-LA

TEAK A5 Dims: 240mm by 200mm by 60mm

Code: ELE-TE-ME

TEAK A6 Dims: 174mm by 157mm by 50mm

Code: ELE-TE-SM

Securit® Elegant large table chalkboard – Wood with lacquered black or Teak finish, with removable transparent frame to insert pages. A4, A5 & A6 portrait.

BLACK A4 Dims: 323mm by 271mm by 70mm

Code: PFT-BL-LA

BLACK A5 Dims: 240mm by 200mm by 60mm

Code: PFT-BL-ME

BLACK A6 Dims: 174mm by 157mm by 50mm

Code: PFT-BL-SM



TEAK A4 Dims: 323mm by 271mm by 70mm

Code: PFT-TE-LA

TEAK A5 Dims: 240mm by 200mm by 60mm

Code: PFT-TE-ME

TEAK A6 Dims: 174mm by 157mm by 50mm

Code: PFT-TE-SM



## Table Chalk Boards Silhouette



Securit® Silhouette cup chalkboard, including chalk marker – Wooden base . Dims: 213mmx335mmx60mm

Code: FBT-CUP

Securit® Silhouette cup chalkboard, including chalk marker – Wooden base. Set of 3 Mini - Dims: 90 x 135 x 20mm

Code: FBT-CUP3



Securit® Silhouette menu table chalkboard, including chalk marker – Aluminium base

Dims:342 x 210 x 60mm Code: FBTA-MENU

Securit® Silhouette menu table chalkboard, including chalk marker – Aluminium base Dims:345 x 210 x 60mm

Code: FBTA-COCKTAIL



Securit® Silhouette menu table chalkboard, including chalk marker – Aluminium base Dims:345 x 230 x 60mm

Code: FBTA-WINE

Securit® Silhouette menu table chalkboard, including chalk marker – Aluminium base Dims:240 x 340 x 60mm

Code: FBTA-PIZZA



# Chalk Boards *Silhouette*



Securit® Silhouette A4 table chalkboard, including chalk marker - Aluminium base.  
Dims: 308x210x60mm  
Code: FBTA-A4



Securit® Silhouette chef table chalkboard, including chalk marker - Aluminium base. Dims: 345x220x60mm  
Code: FBTA-CHEF



Securit® Silhouette arrow chalkboard sign - Including wooden stand with spike and a chalk marker. Dims: 670x492x2mm  
Code: FBS-ARROW



Securit® Silhouette Sandwich chalkboard, including chalk marker - Aluminium base. Dims: 240x340x60mm  
Code: FBTA-SANDWICH

Securit® Silhouette rectangle chalkboard sign - Including wooden stand with spike and a chalk marker. Dims: 735x450x2mm Code: FBS-RECTANGLE



Securit® Silhouette bubble chalkboard tags, including chalk marker - set of 5  
Dims: 180x81x1mm  
Code: TAG-BUBBLE-5



Securit® Silhouette flower chalkboard tag, including chalk marker - set of 5  
Dims: 187x80x1mm  
Code: TAG-FLOWER-5



Securit® Silhouette rectangle chalkboard tag, including chalk marker - set of 5. Dims: 180x80x1mm Code: TAG-RECTANGLE-5



Securit® Silhouette glass chalkboard - including chalk marker and self adhesive mounting strips. Dims: 500x235x3mm  
Code: FB-GLASS



Securit® Silhouette butterfly chalkboard tag, including chalk marker - set of 5. Dims: 180x81x1mm  
Code: TAG-BUTTERFLY-5



Securit® Silhouette bottle chalkboard - including chalk marker and self adhesive mounting strips. Dims: 497x195x3mm  
Code: FB-BOTTLE



Securit® Silhouette bubble chalkboard - including chalk marker and self adhesive mounting strips. Dims: 273x470x3mm Code: FB-BUBBLE



Securit® Silhouette cup chalkboard - including chalk marker and self adhesive mounting strips. Dims: 283x445x3mm  
Code: FB-CUP



Securit® Silhouette glass chalkboard - including chalk marker and self adhesive mounting strips. Dims: 298x377x3mm  
Code: FB-OVAL



# Something Different



Securit® Hexagon cork- & chalkboards - including chalk marker, pins and double sided tape mounting strips - set of 7 pcs (4x chalkboard + 3x cork) - Each Dims: 200x230mm  
Code: FB-CB-HEX

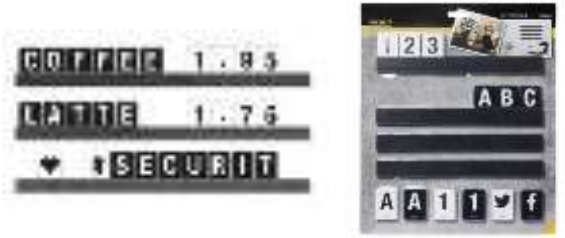

Securit® Letter Shelf, including 169 double sided paper cards with letters, numbers and icons. Dims: 25x250x2mm  
Code: LES-BL-100



Securit® XXL Square Chalkboards - set of 6 Dims: 400x400x2mm  
Code: FB-XXL



Securit® Window poster frame - Double sided and UV resistant - 4 suction cups included - A4. Dims: 360x271x2mm  
Code: PFW-A4-BL



Securit® Letter Shelf, including 169 double sided paper cards with letters, numbers and icons. Dims: 25x250x2mm  
Code: LES-TE-100



Securit® Window poster frame - Double sided and UV resistant - 4 suction cups included - A3. Dims: 523x398x2mm  
Code: PFW-A3-BL



Securit® Stainless Steel Coffee Stencils - Face and Heart - set of 2. Dims: 100x124x1mm  
Code: STN-SS-CO

Securit® Window chalkboard - Double sided writing surface - 4 suction cups included. Dims: 356x271x3mm  
Code:



Securit® Stainless steel signage - (woman, man, woman | man, Arrow, No smoking and wheelchair friendly) - Set of 6 Dims: 100x100x2mm  
Code: SI-SS-SET



Securit® Liquid chalk marker stencil art set - Set of 6 Dims: 320x220x0.05mm  
Code: SECSTN-5



Securit® Window Stencils, including chalk marker - Food & Drink Theme - Set of 3 x A2 Dims: 594x420x0.05mm  
Code: WD-3A2-FD





# Wooden Clipboard Menus & Menu Blocks

Premium Wooden clipboards are strong, good looking and make the perfect menu holder when sitting on a counter or table top. Simply slip your flyer under the fixed metal clip to start promoting. Dark Oak finish on 4mm Veneered MDF Boards. Fixed Metal Silver Clip.

Designed to hold A4 or A5 menus/flyers. Add a Menu Base Block to enable the boards to stand.

A4 Code: WC920G - D

A5 Code: WC921G - D



Display your menus a bit differently using these elastic wooden menu boards. Available in A4 & A5 variants. Comes with 2 black elasticated bands (5mm) Use one or both bands to get the menu display that suits you, landscape or portrait possible from the same board.

Another option to display multiple page menus by using just one band. Available in Natural Oak Finish with veneered 4mm board

A4 size Code:WC894N

A5 size Code:WC895N



Paddle Shaped wooden clipboards are strong, look good and make the perfect menu holder when sitting on a counter or table top. Can be self standing when used with a menu block base. Finish is natural oak with veneered finish and a fixed metal clip. Made to hold A4 or A5 sheets with a 15mm surround border. Also comes with a 8mm diameter for hole wall mounting or hanging. Handle 130mm long. Available in two sizes A4 and A5 portrait.

•A4 size

Code: WC916N

•A5 size

Code: WC899N



## Menu Base Block - Options

Hardwood menu holders with a slanted 4mm groove to allow our Clipboards or Unframed Chalkboards to stand on counters or tables. Works with items up to 4mm thick. Two Sizes available A4 or A5 long with Dark Oak stain. Height - 32mm, Depth - 75mm Groove is 5mm at a 5 degree angle (approx) Hardwood timber used to increase weight to hold securely the two sizes A4 & A5

A4 (210mm W) Code: WC224D

A5 (150mm W) Code: WC245D



Plain menu holder with a 3mm groove to allow menus to stand upright on tables and serve overs. Dimensions:3mm thick, 20mm depth Dark oak stain 150mm (H) x 45mm (H) x 45mm (D) Pack size 10 units.

Code: WC220



Wooden blocks that have a 3mm groove to allow menus and other displays to stand on a table top. Includes 3mm Groove Dark Oak Stain Perfect for table tops. Pack size 10 units Dimensions: 60 x 60 x 60mm, sold in single units. Code: WC209



# On The Menu

## Copper Mesh Menu Holder & Clip



Self Standing Portrait Angled Menu Holders, Polished Copper Mesh finish with matching clip. Slightly oversized to give the full effect of the premium menu holder.

Size: A4

Code: CMA4

Size: A5

Code: CMA5



## A Frame Clipboard Menu



A Frame Menu, chalkboard or natural oak are perfect for displaying on table, counter top or within a display. Comes with metal clip on one side for holding card or paper print. Sizes available: A4, A5, 75mm wide stance. Designed for use with Chalk Pens and Stick Chalk.

Chalkboard Finish A5 Code: WC 865C

Chalkboard Finish A4 Code: WC 864C

Natural Oak A4 Code: WC924 Natural

Natural Oak A5 Code: WC925 Natural

## Printed A4 Menu Chalk Boards

Double Sided Dark Oak Finish, Wooden Based Menu Board with Double Sided Chalkboard finish. Overall Height 310mm and overall width 210mm. **4 printed variants as follows: Hot Carvery, Hot Soup, Butcher Special Offer and Expert Butcher.**

Hot Carvery Code: WOD001PCarvery

Soup Code: WOD001Soup

Special Offer Code: WOD001Butcher

Expert Butcher Code: WOD001Expert



## A4 & A5 Menu Chalk Board

Double Sided Dark Oak Finish, Wooden Based Menu Board with Double Sided Chalkboard finish. Overall Height 310mm and overall width 210mm with a chalkboard surface of 275mm high by 210mm in width. For use with Chalk Pens & Cleaning Solution or standard chalk.

A4 Cost: € 10.98 each Code: WOD 001 A5 Code: WOD 006



## A4 Table Top Chalkboard Menu Holder

Double Sided Dark Oak Finish, Wooden Based Menu Board with Double Sided Chalkboard finish. Overall Height 310mm and overall width 240mm with a chalkboard surface of 297mm high by 210mm in width. For use with Chalk Pens & Cleaning Solution or standard chalk. Code: WOD 004

## A4 & A5 Chalk Board Easel

Single Sided Chalk Board Easel with Dark Oak stain, Easel base. Removable Blackboard allows easy writing/cleaning. Can be used for Chalk Boards or menu cards. A4 Code: WOD 003

A5 Code: WOD 0051



# On The Menu



## Floor Standing A Frame Chalk Board

Double Sided Round Top Dark Oak Stained frame. Stainless steel hinges & stays. For use with stick chalk or chalk pens.

Size: A1 Code: WC150  
Size: A2 Code: WC154

## Floor Standing A Framed chalk Board

Double Sided Dark Oak Wooden A Frame Chalkboard, for use with Chalk Pens or Stick Chalk. Stainless Steel stays & Hinges.

A1 Code: WC151  
A2 Code: WC155



## Dark oak framed chalkboards

are made with a mitred, solid wooden 40mm frame with a shiny chalkboard finish to allow chalk pens to be wiped off easily. Use with Chalk Pens & Cleaning Solution.

Size: A1 625x870mm Code: WC311  
Size: A2 430x630mm Code: WC312  
Size: A3 325x450mm Code: WC313

## Unframed Chalk Board & Shapes

6mm blackboards have a smooth laminate surface that allows chalk pens and stick chalk to work effortlessly. Double sided, comes with pre drilled holes in each corner.

Size: AO (841mmx1189mm) Code: WC630  
Size: A1 (594mmx841mm) Code: WC631  
Size: A2 (420mmx594mm) Code: WC632  
Size: A3 (297mmx420mm) Code: WC633  
Size: A4 (210mmx297mm) Code: WC634  
Size: A5 (148mmx210mm) Code: WC635



Cup shaped Chalkboard, perfect for the Café feel. Made from waterproof 6mm MDF. Hand painted with chalkboard paint Finished & black edges. Designed for use with Stick Chalk & Liquid Chalk.  
Size (W)525mm x (H)370mm Code:WC044G

Grape Bunch shaped Chalkboard, great for highlighting wine offers. Made from waterproof 6mm MDF. Hand painted with chalkboard paint Finished & black edges. Designed for use with Stick Chalk & Liquid Chalk.  
Size (W)420mm x (H)600mm Code:WC041G



Wine bottle shaped Chalkboard, great for highlighting wine offers. Made from waterproof 6mm MDF. Hand painted with chalkboard paint Finished & black edges. Designed for use with Stick Chalk & Liquid Chalk.  
Size (W)159mm x (H)600mm Code:WC043G

Oval Bottle Neck Clip, pack of 5, with chalkboard front, designed to fit wine or spirit bottle necks. 9mm thick blackboard front panel. Designed for use with Stick Chalk only. Size: 70mm wide by 100mm high.  
Pack of 5 Code: WC986AP



# Serve Over Pricing

## Stainless Steel

Stainless steel stand - with ring top holder base plate 80x68mm - thickness 1mm total 55, 105 & 155mm height options

Height 55mm Code: DELI 25  
 Height 105mm Code: DELI 26  
 Height 155mm Code: DELI 27



**Deli Spike SS / Price Card Holder**  
 Stainless Steel spike with ring holder for laminate cards. Size 100mm high.

Code: SS DELI SPIKE



**Stainless Steel ring top holder for price card for laminate cards.**  
 50mm base & 100mm high  
 Code: SSDELIRING50



**40mm high Stainless Steel Deli Stand Price angled spring Clip Top Price Card Holder.** Can be used with laminate cards or PVC Chalk Boards in Serve Over. Height: 40mm Code: DELI 28

**90 mm high Stainless Steel Deli Stand Price angled spring Clip Top Price Card Holder.** Can be used with laminate cards or PVC Chalk Boards in Serve Over. Height: 90mm Code: DELI 29



**Stainless Steel Deli Bowl Clip Price Card Holder with adjustable angle top grip holder.** The Holder can be used with laminate cards or PVC Chalk Boards in Serve Over Counter.  
 Code: DELI 30

**Stainless Steel Deli Clip Price Card Holder angled top grip ring holder.** Can be used with laminate cards or PVC Chalk Boards in Chilled Serve Over Counter or hot counter. Code: SS DELI RING CLIP



## HOT FOOD COUNTER Black Board Tickets

Heat Resistant Black Board ticket for use in the Hot Counter serve over (holds consistency with constant heat up to 100 degrees & is Food Safe Standard Material. For use with Chalk Pens & SS ticket holders above.

Size: 96 x 96mm Code: 8311HOT 96x96  
 Size: 85 x 55mm Code: 8311HOT 85x55

FOR PRINTED HOT TICKETS PLEASE CONTACT OUR OFFICE FOR FURTHER DETAILS



# Treat Holder Price Stand



Stand Alone Reverse Angled Black Stand, for use at front of store "Treat Display". Ticket Holder  
 Size: 115mm x 65mm (Angled Face)  
 Cost Each: € 0.99 Code: HIP 02

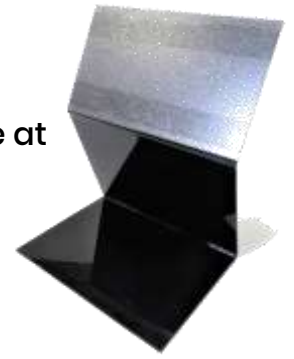

# Serve Over Pricing

Deli Stand, Price Card Holder stand with grip top holder for laminate cards. Both base and top holder swivel for use at different angles.  
 Size: 100mm Code: DELI 07



Deli Stand with block base. Price Card Holder stand with crocodile clip top for holding Chalk Boards or card type signs.  
 Size: 110mm High Code: DELI BLOCK

Deli Stand with Small Clamp Top & Swivel Stem with centred round base  
 Size: 50mm (H) Colour: Black Code: DELI 06



Deli Stand with ball joint for adjusting angle of card, can be used with laminate card or chalkboard.  
 Size: 30mm (H) Colour: Black Code: DELI 10

# Clip On Ticket Holders

Midi Bowl clip, available in Black & also in White.  
 Dims: 55x10x2mm. Black Code: DELI 12  
 White Code: DELI 14



## Basket Clip



Swivel Clamp Holder with Grip attachment. For use in Bread area with clamps going over baskets. Top grip holds laminate card to accommodate pricing. Colour: Transparent  
 Code: 9217857



# Serve Over Pricing

## Clear & Black



Deli Clip with Grip Top for laminate card thickness. Colours available Black & Clear.

Size:	Colour:	Code:
50mm	Clear	P24000
50mm	Black	P24000BO1R



Deli Clip with Clamp Top for laminate card or chalk board thickness. Colours available Black & Clear.

Size:	Colour:	Code:
50mm	Clear	P23001
50mm	Black	P23001BO1R



Deli Stand clear polycarbonate all one piece for use in conjunction with laminate card for pricing.

Size:	Colour:	Code:
110mm H	Clear	DS - 110
80mm H	Clear	DS - 80
110mm H	Black	DS - 110BLACK
30mm H	Clear	DS - 30



Flat Deli Stand with Angled Grip Top for laminate card or chalk board thickness. Colour Black

Size:	Colour:	Code:
20mm (H)	Black	DELI 15



## Clip On Ticket Holders

Securit® Clip tag holder – set of 6 (tags not included)  
 Dims: 55x10x2mm. Code: TAG-HLD-CP



## Fish Serve Over Pricing & Promotion

Ice Spike, Price Card Holder spike with clamp top holder for laminate cards or chalk board inserts. Swivel function holder for adjustable angles. Holds material thickness up to 3mm. Size: 150mm breakable to 100mm. Colour: Transparent Code: 28433 - 00

Transparent Ice Spike, Price Card Holder spike with grip top holder for laminate cards or chalk board inserts. This is a one piece value solution with one position only, for holding laminate cards or PVC chalk boards below, material thickness up to 1.0mm  
 Size: 175mm Code: 9470845



# Chalk Pen & PVC Black Board Tickets

Stand Alone Angled PVC Black Board, for use in the serve over. There is a built in base (45mm deep) which acts as the stand. For use with chalk Marker Pens in catalogue.

Size: 75mm x 75mm (Angled Face) Code: 8311 75x75L



PVC Marker Black Board ticket for use in the chilled serve over. Other sizes available on request. For use with chalk Pens.

Size: 60 x 70mm Code: 8311 60x70

Size: 60 x 90mm Code: 8311 60x90

## Chalk Black Board Adhesive Tickets

Securit® Rectangle Chalkboard stickers – Set of 8

Dims: 47x80x0.04mm

Code: CS-RECT-8



Securit® Oval Chalkboard stickers – Set of 8

Dims: 47x80x0.04mm

Code: CS-OVAL-8



Securit® Waterproof chalk marker white or coloured (Red, Green, Yellow & Blue) For use on Glass or Chalkboard. 2-6mm nib – Sets of 4

White Code: SMA610-V4-WT

Coloured Code: SMA610-V4

Securit® Waterproof chalk marker white or coloured (Red, Green, Yellow & Blue) For use on Glass or Chalkboard. 7-15mm nib. Sets of 4

White Code: SMA820-V4-WT

Coloured Code: SMA820-V4



Poster Pen Cleaner – Transparent bottle with spray nozzle for ease of use when wiping poster pen from black boards.

Size: 750mm Code: SECCLEAN-GR



Securit® Magic cleaning sponge – Set of 2

Dims: 25x60x105mm

Code: SPONGE-2



Securit® Chalkboard paint – Small

Size: 250ml

Code: PNT-BL-SM



Securit® Chalkboard paint – Large

Size: 2500ml

Code: PNT-BL-LA



Stick Chalk, pack of 12 in assorted Colours. Dust Free.

Natural calcium Chalk

Code: P386



Stick Chalk, pack of 40 all white in Colour. Dust Free.

Natural calcium Chalk

Code: P378



# HACCP Station

Universal Wall Mounted HACCP Station. Material Acrylic, with 4 landscape tiered shelf slots. Code: HACCP

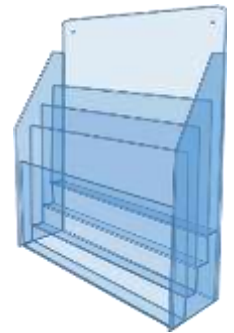

## Menu Holders – Inserts For Wood Base

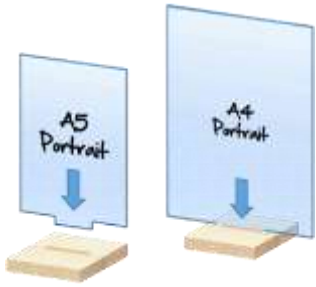

A5 & A4 Portrait Acrylic holders “U” Shaped pocket with extended tab for slotting into wooden bases to form a double sided menu holder. Material is 2mm acrylic pocket and Birch Ply 18mm base (120mm Square), with a slot for fixing Acrylic menu holder.  
Complete A5 Code: WODACA5  
Complete A4 Code: WODACA4

## ACRYLIC... Menu Holders with Stainless Steel Base

Securit® Removable double-sided acrylic table display with stainless steel base -A4, A5 & A6

A4 Dims:332x207x75 Code: SEC-PFT-ACM-A4  
A5 Dims:243x150x74 Code: SEC-PFT-ACM-A5  
A6 Dims:165x105x74 Code: SEC-PFT-ACM-A6



## Value Option Polystyrene Menu Holders

Self Standing Portrait Angled Menu Holder, Material Polystyrene.  
Size: A4 Code: PS A4

## ACRYLIC... Menu Holders



Self Standing Portrait Angled Menu Holder, Material 2mm Acrylic.  
Size: A4 Code: ACR 14  
Size: A5 Code: ACR 18

Portrait double sided menu holder. Self standing. Material 2mm Acrylic.  
Size: A4 Code: ACR4  
Size: A5 Code: ACR2  
Size: A6 Code: ACR021

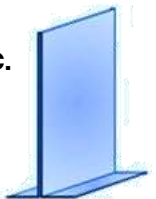

Portrait Angled Menu Holder With Sucker Pads on base. Material Acrylic.  
Size: A4 Code: ACR 15

Portrait Angled Menu Holder With Clamp function on base. Material PETG  
Size: A4 Code: ACR 13



Portrait (P) or Landscape (LS) wall mounted menu holder. Material Acrylic. Self adhesive pads on one side to fix to a wall type surface.  
Size: A4 Portrait Code: ACR23  
Size: A4 L/Scape Code: ACR26





# Pizza Display

6 Facings deep upright pizza display. Material 5.0mm PTEG. Dims:150mmW x 435mmD x 135mmH  
Code: PET-54



## Y Shaped Table Top Menu

Securit® 6 sided Acrylic Transparent poster holder – Y-Shaped  
A5 Dims: 210x135x135mm Code: PFT-ACY-A5  
A6 Dims: 150x95x95mm Code:PFT-ACY-A6



## Petrol Pump Toppers

Self Standing A4 Landscape Petrol Pump POS Holder, Material PETG with Foam PVC Base including Tape for Fixing. Holds a double sided print in a landscape format.  
Size: A4 Code: PET23



## Poster Holders

Portrait Menu Holder With 90 degree bend for mounting under product or boxes for displaying Offers, or other information on pallet or stack displays.  
Material PVC. Size: A4  
Cost each: €0.85  
Code: PVC 05

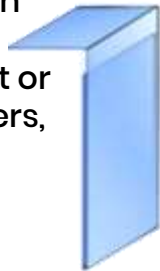

Portrait wall mounted PVC menu holder, with self adhesive tape on one side to fix to a flat type surface.  
Size: Code:  
A3 PVC 26  
A4 PVC 10  
A5 PVC 41

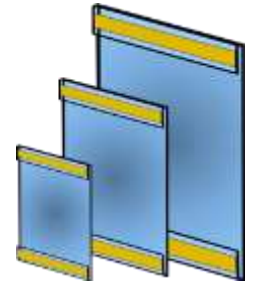

PVC WINDOW POSTER HOLDER WITH SUCTION CUPS on top for mounting onto glass for displaying posters either double or single sided messages. Material 0.4mm PVC .  
Can also be supplied with out the suction cups as shown to the below right.

Size:  
A4  
A3  
A2  
A1  
20" by 30"

Code:  
PVC 15  
PVC 25  
PVC 16  
PVC 17  
PVC 18



Size:  
A4  
A3  
A2  
A1  
20" x 30"

Code:  
PVC 33  
PVC 32  
PVC 31  
PVC 30  
PVC 34



Double Sided Black T Shape Menu Board with a two part construction. Dimensions on top board 340mm H by 210mm W , comes with a 10mm Foam Board base. Top Sign material is 5mm Foam Board. Single & double sided options, of standard PVC wallet.

Single Sided PVC-1 Wallet Code: ACR 14 BL T 1PVC T  
Double Sided PVC-2 Wallets Code: ACR 14 BL T 2PVC T



The easy to fit reusable Poster System & removable leaving no residue on glass.



- Easy Fitting or repositioning
- Removable, leaving no residue
- Easy to change poster
- Double sided display on glass
- Brand-able header and footer
- Wide range of solutions & uses, including Offers, Menus, Opening Hours or Safety Notices.



Code, Size & Colour

- Posterfix Portrait Red A4
- Posterfix Portrait Grey A4
- Posterfix Portrait Grey A3
- Posterfix Portrait Grey A2
- Posterfix Portrait Grey A1



## Window Cable Display

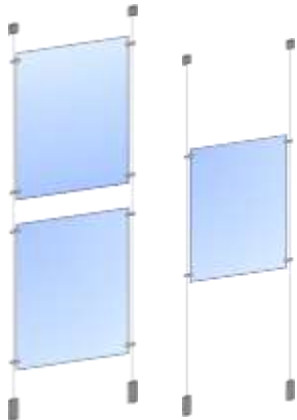

Window Cable display set consisting of the following:

2 by 4m wire with top and bottom fixings, 4 by Cable Clips Large 6mm or 4 by Cable Clips Small 2mm and one by acrylic wallet with cover clip.

Size: A3 297 x 420mm

Code: CSET A3

Size: A2 420 x 594mm

Code: CSET A2

Size: A1 594 x 841mm

Code: CSET A1

Fitting costs available on request.

## Category Signage Magnetic Arm



**Magnetic Arm** Aisle Sign Holder for under shelf on metal shelves. Recommended for use in refrigeration rather than main floor ambient shelving. Base is adjustable for use where shelves are angled & the arm has 2 hooks for holding pre punched signage  
Code: MAG-ARM

**G Clamp** can take print of 5 to 6mm thick (recommended material Foam Board). The sign holder is hinged, so the Aisle Fin will re-centre when moved. Code: MET 01

**Under Shelf Bracket Clamp.** Takes print of 5 thick. The sign holder is hinged, so the Aisle Fin will re-centre when moved. Bracket attaches to the underside of the shelf bracket. The front of the bracket angle can be adjusted for use on angled shelves. Designed for angled shelves and also usable for shelves with under shelf lighting.  
Code: METAL CAT CLAMP



# Signage – Snap Frames & Pavement Signs

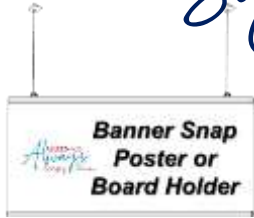

**Banner Snap – Headboard Holders.** Consists of Top Bar with two eyelets for hanging & Bottom Bar for base of sign. Both aluminium bars snap closed to grip sign. Included in set are two ceiling clips and spring hanging wires.  
 Cost Per Set €18.50 Code: 00.235 – PH

Wall mounted 25mm edge profile Snap Frame from A1 to 20” by 30” sizes & 32mm edge profile Snap Frame in AO size. Silver anodised finish with mitred corners.

Size:

- AO
- A1
- A2
- A3
- A4
- 20” x 30”

Code:

- 05.AO Snap Frame
- 05.111-WR
- 05.112-WR
- 05.113-WR
- 05.114-WR
- 11.357



**Wind Talker**, with a moulded plastic base – recommended to fill with sand to give extra weight to the stand in order to be more wind resistant. Rounded corners and also has wheels on one side to enable stand to be wheeled to location. Poster on both sides, A1 Size is available in Black or Silver Anodised Finish & AO is only available in Silver Anodised finish.

Cost: A1 Code: WTA1  
 Cost: AO Code: WTAO

A frame, brushed aluminium finish, rounded corners takes poster on both sides. Recommended for indoor use only. Size A1, other sizes available on request only.

Code: 15.100

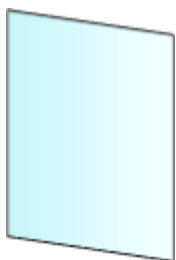

Replacement Covers for Snap Frame Signage Holders. Material is anti reflective and is available in the below sizes.

Size:	Code:
AO 841mm x 1189mm	RC AO
A1 594mm x 841mm	RC A1
A2 420mm x 594mm	RC A2
A3 297mm x 420mm	RC A3

## Signage Black Board Inserts



PVC Marker Black Board insert for wall mounted snap frames or standard frames. Other sizes available on request. For use with chalk Marker Pens below.

Size:	Code:
A1	8311971
A2	8311972
A3	8311973
A4(5 Pack)	8311974



# Frame & Accessory Sets

A4 Self standing pole, frame, insert and plastic base.  
Black Pole height 300mm extends to 600mm.  
A4 Frame Clear or Black  
Code: SET 01

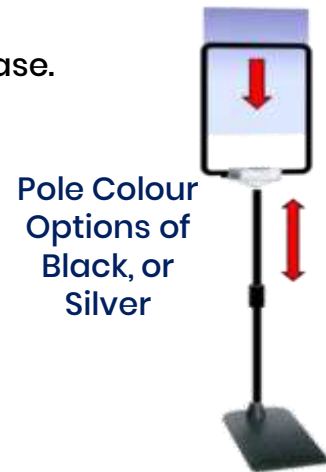

A3 Self standing pole, frame, insert and plastic base.  
Size: Pole 300 mm extends to 600 mm  
A3 Frame Clear or Black  
Code: SET 05

## Frame, Insert & Magnet Base



Frame, insert and magnet base White or Black Magnet.  
Size; A4 Frame Clear or Black

Black magnet set  
White magnet set

Code: SET 03  
Code: SET 04

## A4 Wine Topper, Frame & Insert

Bottleneck Holder for off licence, goes over the top of the bottle and has a frame adaptor included. Inclusive of A4 Frame and Insert.  
Colours – Black or Clear. Code: SET 08



## Suspension Frame Sets

Frame, insert & skyline track for hanging frames. 2m silver anodised profile complete with hanging wires, ceiling clips and 4 x A4 frames with inserts.

2m Set: Code: 2 MTR SUSPENSION

Connector Code: 9178369



## Freezer Rail Sets

Frame, insert & Freezer Track. The Track is a PVC profile 1250mm long, with a foam adhesive base for easy fitting. The placement of the track is shown in pictures to the right. The set comes complete with three A4 frames with inserts and three frame clips which can be clipped on at any point along the track.  
1250mm Set: Code: SET 07



# Frames & Accessories

## Extendable Pole & Base

Size:	Code:
Black pole 750 to 1500	8312622
Black pole 300 to 600	8312620
Silver Pole 300 to 600	8312621
Plastic Base	8312655
Metal Base	8312631



## A4 Frame & Insert

Size:	Code Clear / Black:
A4 Clear / Black Frame	8312594 / 8312548
A3 Clear / Black Frame	8312571 / 8312538
A4 Insert	8312644
A3 Insert	8312643

## 90 Degree Magnet.

Pack Quantity: 10's/25's

Code:
8371059 Black
8312575 White



Fruit & Veg Black Box Clamp, use with standard frames, for use in Heavy Duty Areas, such as Fruit & Veg, Wood Crate or Box Displays. Frame & Insert not included Code: 9173217

Clear Clamp for use with standard frames for glass edges such as Spider Fridges or open cheese displays. Frame & Insert not included Code: 9173219



Telescopic Poles with "T" piece and Spring Holder for mounting poles on wire baskets. Size available extends to 420mm. Frame & Insert not included. Colour: Dark grey powder coated. Code: 8312637

# Display Bin Poster Surrounds

DUMP BIN TALKER. A2 PVC Poster wallet. Wallet is fixed on the top of the dump bin as shown and holds an A2 paper quality poster. Can be used to the front of a single bin or where there are a number of bins together to create a surround as shown.

For Use With 420 square wire bin above

Code: PVC 16db (Wallet with Cables)

Code: A2 P SO white red

Code: A2 P SO whitegreen

Code: A2 "Save on this Special offers



# Special Offer

## Wire Display Bin Sets



Wire Display Basket ALSO includes Spring Mounted Pole with Black or Clear A4 Frame & Insert. Polished zinc finish. Product has a collapsible base which can be moved upwards as the product is selling out. Ideal for mid floor, end of aisle or side displays.

Standard Size 420 Square x 770 High Code: DUMP BIN SET C

Large Size 600 Square x 770 High Code: DUMP BIN SET LG



Tego Style Shelving

## Shelf Edge Merchandising Hook

Use on gondola runs at shelf edge to maximise selling space. Promote impulse purchasing while creating "Secondary Sightings" the unit holds two Hang Strips on self contained hooks as shown. Metal construction with black powder coated finish. Suitable for Tego or Eden shelving as the units are fixed with a screw & wingnut through holes in the front "U" channel on either side of the shelf.

Code: MET 03



## Merchandising Hang Strips

For use on shelf edge or for hanging products on the edge of displays. The main purpose is for secondary sighting of products, which in turn promotes impulse purchases. Strip is only suitable for light weight products. There are 12 hooks to a strip, in a length of 646mm and the colour of the strip is transparent.

Code: 007

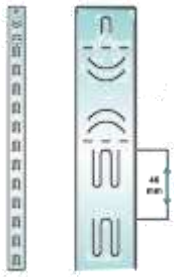

For use on shelf edge or for hanging products on the edge of displays. The secondary sighting of products promotes impulse purchases. Strip is suitable for light weight products. There are 6 hooks to a strip, in a length of 380mm and there is a connecting button at the end of each strip, by where another strip can be connected to make a 12 hook hanging strip. The hanging hook is sold separately and shown below (Code: 601-254)

Code: 601-132



White Plastic Hook for hanging above Merchandising Hang Strip on displays or shelf edge. Code: 601-254



Metal Clip strip - With hanging hook .. colour zinc finish There are 12 hooks to a strip, in a length of 700mm. The header panel is 32x80mm.

Code: MET300



# Food Information Regulations (FIR)

Wall Fixed Binder Holder  
A4 Binder Brochure holder with fixings  
Code:  
EX-A4binder WML

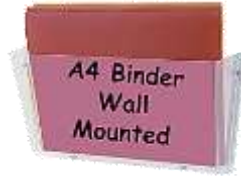

Freestanding Centre Floor  
1.4m high pole with A4 snap frame and metal shelf to take A4 Binder  
Code: SBS Binder Set  
Internal dimensions of metal shelf  
268mm wide x 58mm deep



## Brochure Stands



**Single Sided Pole with A4 Frame and Shelf** 1400mm Aluminium Pole & base, 1 by A4 Snap Frame, 25mm Profile and 1 by silver metal A4 brochure shelf.  
Code: SBS – SET 1



**Double Sided Pole with A4 Frame and Shelf** on each side. 1400mm Aluminium Pole & base, 2 by A4 Snap Frame, 25mm Profile and 2 silver metal A4 brochure shelves.  
Code: DBS – SET 1



**Single Sided Pole with 2 by A4 Frame and Shelf** 1400mm Aluminium Pole & base, 2 by A4 Snap Frame, 25mm Profile and 1 by silver metal A4 brochure shelf  
Code: SBS – SET 2



**Double Sided Pole with A4 Frame and Leaflet Box** on each side. 1400mm Aluminium Pole & base with 2 by A4 Snap Frame, 25mm Profile and 2 by Polycarbonate A4 Brochure holders.  
Code: DBS – SET 3



**Single Sided Pole with A3 Landscape Frame and A4 Leaflet Box.** 1400mm Aluminium Pole & base, 1 by A3 Snap Frame (25mm Profile) and 1 by Polycarbonate A4 brochure holder.  
Code: SBS – SET 4



**Double Sided Pole with A3 Landscape Frame and A4 Leaflet Box** on each side. 1400mm Aluminium Pole & base, 2 by A3 Snap Frame (25mm Profile) and 2 by A4 Polycarbonate Brochures Holders.  
Code: DBS – SET 4

## Self Standing Brochure Holders



Description: A4 Self Standing Leaflet Box  
Code: EX – 1A



Description: A5 Self Standing Leaflet Box  
Code: EX – 2



Description: 1/3 A4 Self Standing Leaflet Box  
Code: EX – 3

## Wall Mounted Brochure Holders

A4 Wall Mounted Leaflet Box  
Code: EX – 10

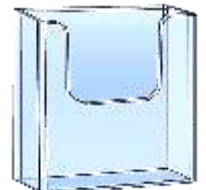

A5 Wall Mounted Leaflet Box  
Code: EX – 11



1/3 A4 Wall Mounted Leaflet Box  
Code: EX – 12



# Wire Shopping Baskets – Miscellaneous Products

19ltr Wire Basket with polished zinc finish. Various handle colours available including Red, Green, Black. Quantity 20 per box.  
Code: 19L - Colour

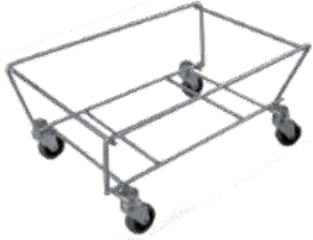

Mobile Basket Stacker, Available in polished zinc finish to suit plastic and wire basket sizes.  
Code: Basket Stacker No Handle

Hi-Back Basket Stacker Mobile. Polished zinc finish to suit the Wire baskets, with 75mm wheels and suitable for 19L and 25L baskets.  
Code: Hibackstacker



Mobile Basket Stacker, Available in polished zinc finish to suit plastic and wire basket sizes.  
Code: BASKETSTACKSIDES

Plastic Moulded Kick Stool – with collapsible wheels for stability when in use. Height 430mm, Top Diameter 300mm, Bottom Diameter 450mm. Colour light grey.  
Code: KICKSTOOL PL



Metal Kick Stool – with collapsible wheels for stability when in use. Height 430mm, Top Diameter 300mm, Bottom Diameter 450mm. Colour: Grey  
Code: KICKSTOOL



Stand Alone Fruit & Veg Bag Holder – Used for holding bag rolls in the Fruit & Veg area. C/W lid & tear pin.  
Code: BAG HOLDER STAND



Fruit & Veg Bag Holder – Used for holding bag rolls in the Fruit & Veg area on angled displays  
Code: BAG HOLDER

STOCK TROLLEY – Height 1190 mm – Width 500 mm – Length 1240 mm C/W 2 directional wheels & 2 set wheels  
Code: STOCKTROLLEY



Adjustable Pallet Guard – Easy to move and to set up, the 7 inch high Pallet Guard can be placed in various places throughout the store. Highlighting displays while protecting customers from exposed pallets on floor displays. Adjustable to suit Standard or Euro pallets. Code: PG-07





# Basket Trolley



**Two Basket Trolley.** Encourages extra impulse sales for basket shoppers. Available with Red or Black handle.

Red Code: T6 RED

Black Code: T6 BLACK



## Plastic Shopping Baskets



**38L Wheeled Basket** with extendable handle. Encourages impulse sales for basket shoppers. Available in Red, Black, Green or Blue, for other colours please contact our office on 01 4587470

Red Code: 38L RED

Black Code: 38L BLACK



**28ltr Plastic Basket** with two black handles. Various colours available including Red, Green, Blue & Black.





Code: 28LPLBasket – Colour

**22ltr Plastic Basket** with single black handle. Various colours available including Red, Green, Blue & Black.

Code: 22LPLBasket – Colour



### Baskets Standard Colours

-  Black
-  Blue
-  Green
-  Red

## Our New Eco Friendly Rolling Basket....

We can do it if we all pull together

Reduce Reuse Recycle



Code: ECO 38L

The ECO 38L Trolley Basket

BE SEEN TO BE GREEN

Basket made from recycled material, colour as shown

100% Recycled 28L Basket.

Code: ECO 28L

Basket & Handles made from recycled material.

Colour is black with two black handles.



Code: ECO 22L

100% Recycled 22L Basket.

Basket & Handle made from recycled material.

Colour is black with one black handle.



# Magazine Display Racks

Code:

MTSIT665/65  
 MTSIT665/100  
 MTSIT1000/65  
 MTSIT1250/65  
 MTSIT1000/100  
 MTSIT1250/100

Bay Width:

665mm  
 665mm  
 1000mm  
 1250mm  
 1000mm  
 1250mm

1 TIER

Standard  
Volume



High  
Volume

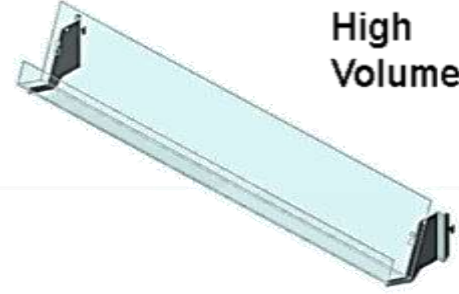

Standard  
Volume

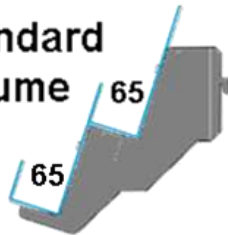

High  
Volume

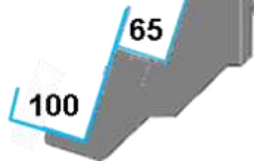

Code:

MTS2T665/65/65  
 MTS2T665/65/100  
 MTS2T1000/65/65  
 MTS2T1000/65/100  
 MTS2T1250/65/65  
 MTS2T1250/65/100

Bay Width:

665mm  
 665mm  
 1000mm  
 1000mm  
 1250mm  
 1250mm

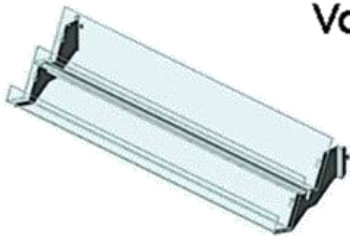

2 TIER

3 TIER

Standard  
Volume

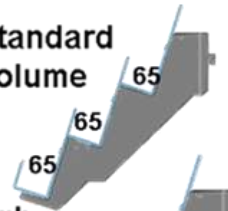

High  
Volume

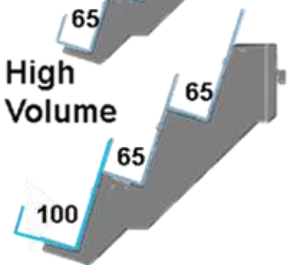

Code:

MTS3T665/65/65/65  
 MTS3T665/65/65/100  
 MTS3T1000/65/65/65  
 MTS3T1000/65/65/100  
 MTS3T1250/65/65/65  
 MTS3T1250/65/65/100

Bay Width:

665mm  
 665mm  
 1000mm  
 1000mm  
 1250mm  
 1250mm



Standard  
Volume

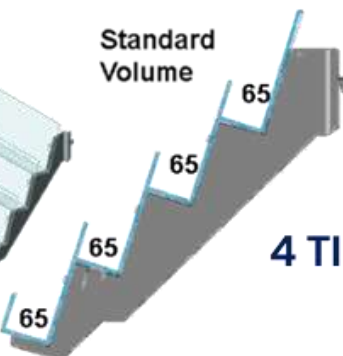

4 TIER

Code:

MTS4T665/65/65/65/65  
 MTS4T1000/65/65/65/65  
 MTS4T1250/65/65/65/65

Bay Width:

665mm  
 1000mm  
 1250mm



# Newspaper Display Rack

Single Tier Single Tier for use with 1M bays. Shelf Depth is 160mm and comes complete with 39mm high data strip. Standard fitting for Tego, Eden, Radford type shelving.  
Code:VNBIT1000/160

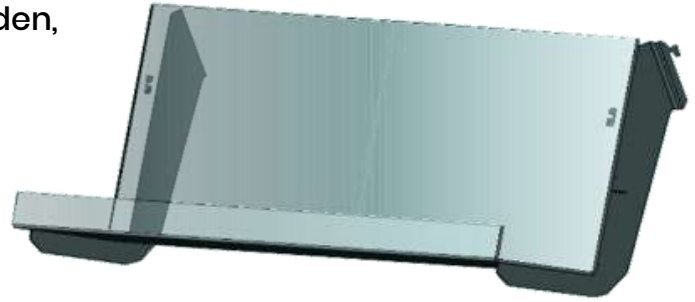

## Newspaper Display Stands

Newspaper Display Stands. Options include 12 titles, 8 Titles & 4 Titles. Stands are of Metal Construction with powder coated finish and comes with 4 castors & locking options for wheels.

Code:  
News Tree  
News Tower Double  
News Tower Single

Dimensions:  
640mmW X 810mmD X 1310mmH  
660mmW X 460mmD X 1310mmH  
410mmW X 460mmD X 1310mmH

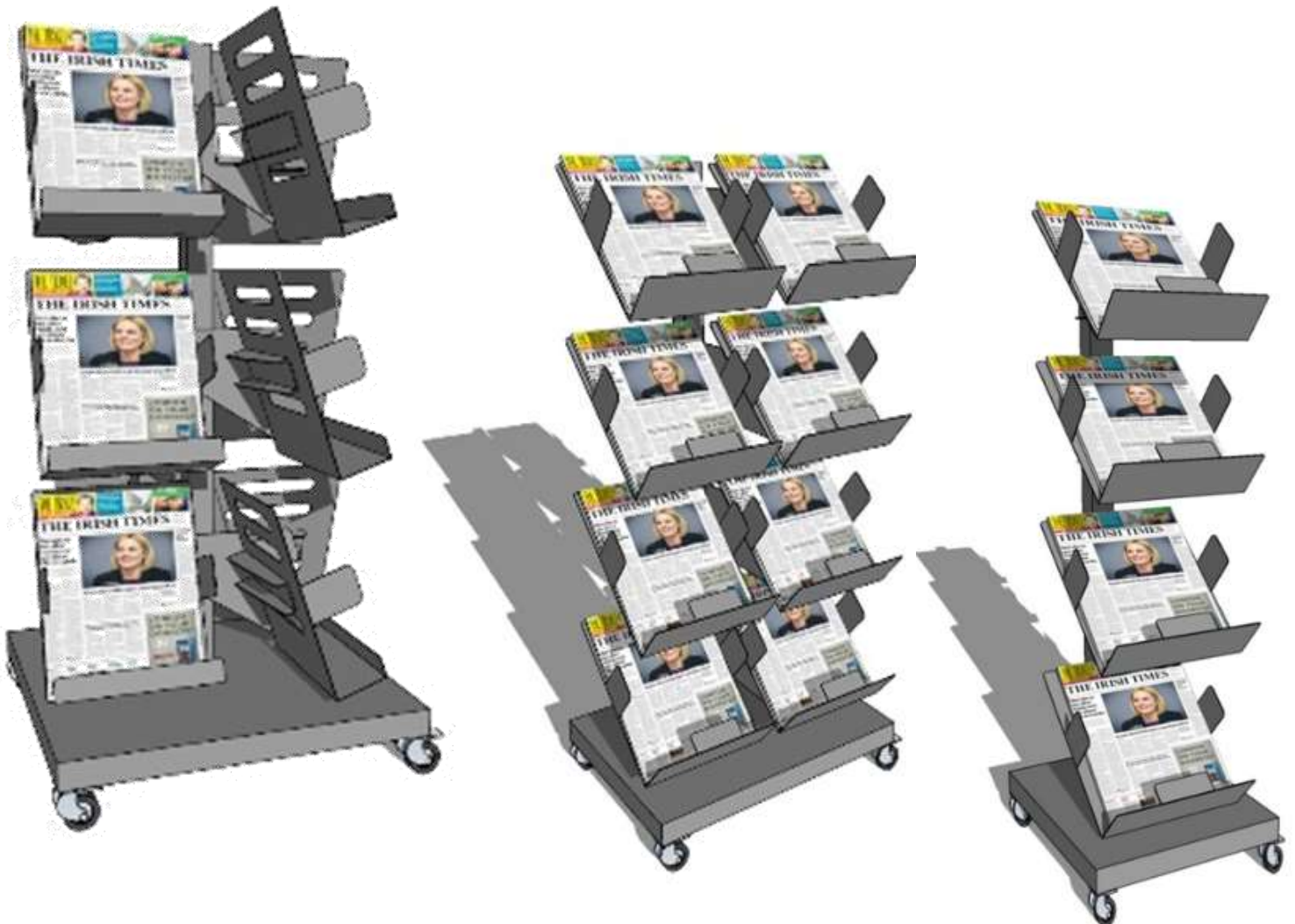

# Ceiling Hanging Wires & Clips

Solid ceiling hook for suspending POS signs.

Size:	Code:
65mm S Hook	1617
150mm	8350 329
300mm	8350 330
500mm	8350 331
700mm	

8350 332

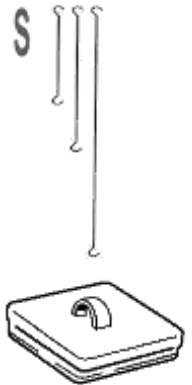

Sign ceiling grid clip.  
Code: 7103



Stick on ceiling clip.  
Code: 2279

Sign Wire ceiling grid clip.  
Code: 8311104



Clamp on ceiling grid clip  
Code: 9217859



## Budget Q Control System



Securit® Budget retractable barrier set (pole & base) – Black nylon tape (2100mm) – Set of 2

Dims: 930 x 330 x 330 mm | 7,9kg  
Code: RS-RT-LW-CH

## Standard Q Control System



Securit® retractable barrier set for wall mounting – Red nylon tape (2100mm) – Set of 2

Dims: 143 x 75 x 50 mm | 0.4kg  
Code: RS-RTWM-RVS-RD



Securit® retractable barrier set for wall mounting – Grey nylon tape (2100mm) – Set of 2

Dims: 143 x 75 x 50 mm | 0.4kg  
Code: RS-RTWM-RVS-GY

Securit® Retractable barrier poster frame – stainless steel – screws to top of post – A4 Dims: 453 x 218 x 67mm  
Code: RS-SIGN-A4-PS

Securit® retractable barrier set (pole & base) – Red nylon tape (2100mm) –

Dims: 1010 x 510 x 330 mm | 7,9kg  
Code: RS-RT-RVS-RD- SET

Securit® retractable barrier set (pole & base) – Grey nylon tape (2100mm) –

Dims: 1010 x 510 x 330 mm | 7,9kg  
Code: RS-RT-RVS-GY- SET



# *In Queue* Merchandising

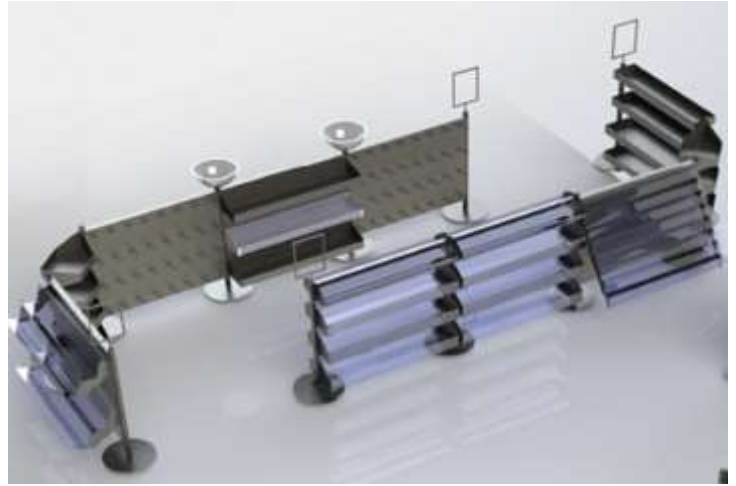

- Completely Adaptable with standard Tego/Eden type Shelving systems (standard slot uprights)
- Robust Metal Frame Work (powder coated finish)
- Double Sided Shop-Ability
- Angled Corner Units (additional selling space)
- Choice of Acrylic or Metal View Through Shelves
- Trough Bin Shelving Available (high volume/bulk products)
- Compatible With Standard Cross Bars & Hooks
- Compatible With Tego/Eden Type Back Panels & Shelving
- Multi-Functional Q System Options Include
  - A4 Directional Signage
  - Magazine Shelving Options
  - Metal View Through Shelving Options
  - Acrylic View Through Shelving Options
  - Merchandising Bowl Option
  - Bulk Trough Bins
  - Standard Crossbar & Merchandising Hook Solution
  - Standard Tego/Eden Compatibility for Shelving or Back Panels
  - Increased Selling Space Using Corner Units

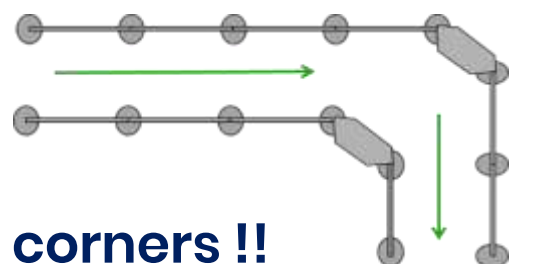

*Extra* selling space on corners !!  
**Contact office for further details**



# Hooks *With* Pricing Arms

## Rear Support Bar (RSB)

Rear Support Bar suitable for main floor Dry Grocery Shelving Systems. For use with RSB Hooks.

Width Size:

665 mm ( 7 mm Solid )  
 1000 mm ( 7 mm Solid )  
 1250 mm ( 7 mm Solid )

Code:

RSB BAR 665  
 RSB BAR 1000  
 RSB BAR 1250



## Rear Support Bar (RSB) Hooks

Single Rear Support Bar hook with pricing arm 6 or 8 mm wire thickness lengths as below, back plate to suit 7 mm RSB Bar

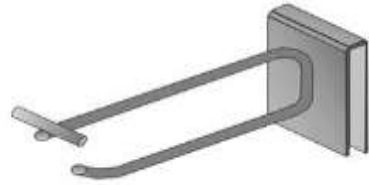

Size:

200mm ( 6 mm wire )  
 300mm ( 8 mm wire )

Code:

RSBS - 200  
 RSBS - 300

Double Rear Support Bar hook with pricing arm 5 mm wire thickness lengths as below, back plate to suit 7 mm RSB Bar

Size:

200mm ( 5 mm wire )  
 300mm ( 5 mm wire )

Code:

RSBD - 200  
 RSBD - 300

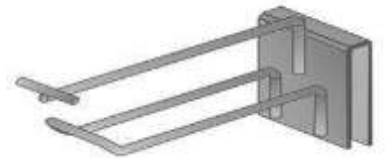

## Slat Wall Hooks

Single Slat Wall hook with pricing arm 6 mm wire thickness lengths as below, back plate to suit Slat Wall

Size:

150 mm ( 6 mm wire )  
 200 mm ( 6 mm wire )  
 250 mm ( 6 mm wire )  
 300 mm ( 6 mm wire )

Code:

SLATS - 150  
 SLATS - 200  
 SLATS - 250  
 SLATS - 300

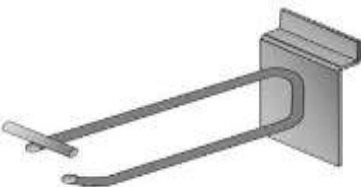

Double Slat Wall hook with pricing arm 5 mm wire thickness lengths as below, back plate to suit Slat Wall

Size:

150 mm ( 5 mm wire )  
 200 mm ( 5 mm wire )  
 250 mm ( 5 mm wire )  
 300 mm ( 5 mm wire )

Code:

SLATD - 150  
 SLATD - 200  
 SLATD - 250  
 SLATD - 300

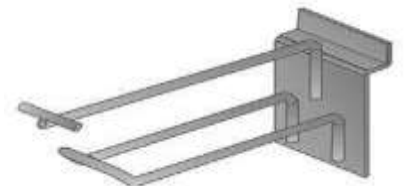

## Price Tags

Price Tag for Hooks with a pricing arm

Size: 39mm x 62mm ticket holder clear or white

Code: WMVP

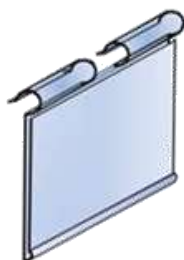

Price Tag for Double Peg hook

Size: 27mm x 32mm ticket holder

Code: 1000-5



# Display Highlighting & POS



End Display Point Of Sale – including Ladder Racks, Side Canopy Sets, Over End Headboard Brackets or Banner Snaps & Side End Framed Head Board Holders. Fitting service available, pricing available on request, please contact office for further details.



Ladder Head Board Holder with hooks, slots into the existing ladder rack and holds new POS small headboard over ladder racks.

550mm – 30x30mm box section RAL9006

Code: Ladder HB 550

665mm – 30x30mm box section RAL9006

Code: Ladder HB 665



Banner Snap – Headboard Holders. Consists of Top Bar with two eyelets for hanging & Bottom Bar for base of sign. Bars snap closed to grip sign. Included in set are two ceiling clips and spring hanging wires for suspending sign from grid ceiling.

Code: 00.235 – PH

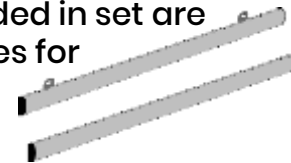

## Hand Label Solutions & Accessories



1 and 2 printing lines with 6 to 20 printing digits, suitable for 22 x 12 and 22 x 16 wavy edge labels for price marking. Tovel Entry meets the demand of low volume in-store labelling.



Model	Description	digits per line	Label size	CODE
1 line	8 printing digits	8	26 x 12	9298517
2 line	18 printing digits	8-10	26 x 16	9298518



### Ink Roll Replacements TOVEL Entry

5 ink rolls p. Blister pack suitable for minimum 1 box of labels.

Colour: Black Code: 9294071



## Price Labels

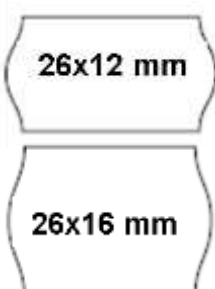

26 x 12 labels	Plain Label Code
26 x 12 White Permanent	9193883
26 x 12 White Removable	9199600
26 x 16 labels	Plain Label Code
26 x 16 White Permanent	9197072

1500 per roll  
1500 per roll

1200 per roll





**ALLIED POS**  
*Always Bringing More...*

**Allied Point of Sale Limited,  
Unit 10 Block 14G, Beechwood Buildings,  
Greenogue Business Park,  
Rathcoole, Dublin 24.  
Phone: 00353 (0)1 4587470  
Fax: 00353 (0)1 4587472  
E Mail: [sales@alliedpointofsale.ie](mailto:sales@alliedpointofsale.ie)  
Web: [www.alliedpointofsale.ie](http://www.alliedpointofsale.ie)**

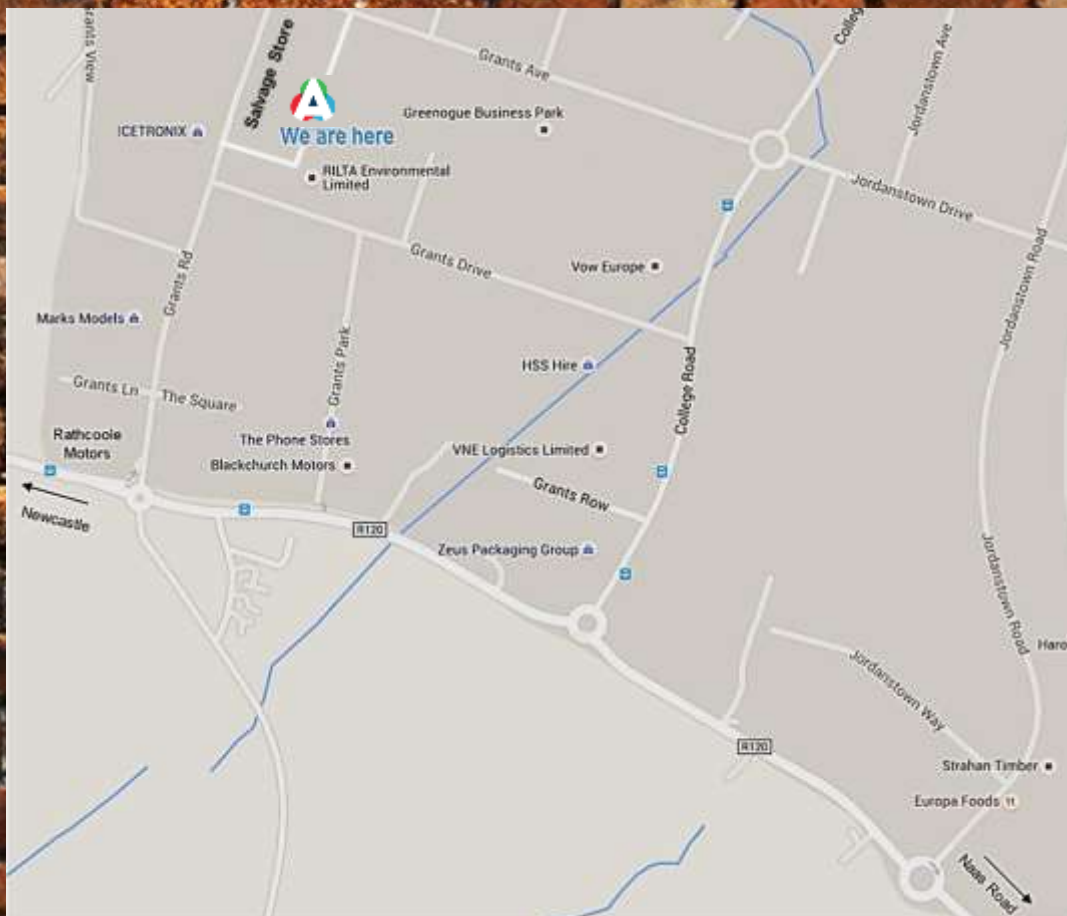

The prices in the above catalogue are valid until 30/06/2021. Ownership of any goods remain the property of Allied Point of Sale Ltd until all monies due are paid in full. All products/prices are subject to availability. Updated catalogue Coming Soon.....